



®

AXIOMTEK

OPS880-HM Series

**Intel Open Pluggable Specification
Box**

User's Manual



Disclaimers

This manual has been carefully checked and believed to contain accurate information. Axiomtek Co., Ltd. assumes no responsibility for any infringements of patents or any third party's rights, and any liability arising from such use.

Axiomtek does not warrant or assume any legal liability or responsibility for the accuracy, completeness or usefulness of any information in this document. Axiomtek does not make any commitment to update the information in this manual.

Axiomtek reserves the right to change or revise this document and/or product at any time without notice.

No part of this document may be reproduced, stored in a retrieval system, or transmitted, in any form or by any means, electronic, mechanical, photocopying, recording, or otherwise, without the prior written permission of Axiomtek Co., Ltd.

©Copyright 2013 Axiomtek Co., Ltd.

All Rights Reserved

March 2016, Version A3

Printed in Taiwan

Safety Approvals

- ◆ CE Marking
- ◆ FCC Class A

◆ FCC Compliance

This equipment has been tested in compliance with the limits for a Class A digital device, pursuant to Part 15 of the FCC Rules. These limits are meant to provide reasonable protection against harmful interference in a residential installation. If not installed and used in accordance with proper instructions, this equipment might generate or radiate radio frequency energy and cause harmful interference to radio communications. However, there is no guarantee that interference will not occur in a particular installation. If this equipment does cause harmful interference to radio or television reception, which can be determined by turning the equipment off and on, the user is encouraged to try to correct the interference by one or more of the following methods:

1. Increase the separation between the equipment and receiver.
2. Connect the equipment to another outlet of a circuit that doesn't connect with the receiver.
3. Consult the dealer or an experienced radio/TV technician for help.

Shielded interface cables must be used in order to comply with the emission limits.

Safety Precautions

Before getting started, please read the following important safety precautions.

1. The OPS880-HM series does not come equipped with an operating system. An operating system must be loaded first before installing any software into the computer.
2. Be sure to ground yourself to prevent static charge when installing the internal components. Use a grounding wrist strap and place all electronic components in any static-shielded devices. Most electronic components are sensitive to static electrical charge.
3. Disconnect the power cord from the OPS880-HM series before any installation. Be sure both the system and external devices are turned OFF. A sudden surge of power could ruin sensitive components that the OPS880-HM series must be properly grounded.
4. Make sure it is the correct voltage of the power source before connecting the equipment to the power outlet.
5. The brightness of the flat panel display will be getting weaker as a result of frequent usage. However, the operating period varies depending on the application environment.
6. The flat panel display is not susceptible to shock or vibration. When assembling the OPS880-HM series, make sure it is securely installed.
7. Do not leave this equipment in an uncontrolled environment where the storage temperature is below 0°C or above 45°C. It may damage the equipment.
8. External equipment intended for connection to signal input/out or other connectors shall comply with relevant UL/IEC standard.
9. Do not open the back cover of the system. If opening the cover for maintenance is a must, only a trained technician is allowed to do so. Integrated circuits on computer boards are sensitive to static electricity. To avoid damaging chips from electrostatic discharge, observe the following precautions:
 - Before handling a board or integrated circuit, touch an unpainted portion of the system unit chassis for a few seconds. This will help to discharge any static electricity on your body.
 - When handling boards and components, wear a wrist-grounding strap, available from most electronic component stores.

Trademarks Acknowledgments

Axiomtek is a trademark of Axiomtek Co., Ltd.

IBM, PC/AT, PS/2, VGA are trademarks of International Business Machines Corporation.

Intel[®] and Atom[™] are registered trademarks of Intel Corporation.

MS-DOS, Microsoft C and Quick BASIC are trademarks of Microsoft Corporation.

VIA is a trademark of VIA Technologies, Inc.

SST is a trademark of Silicon Storage Technology, Inc.

UMC is a trademark of United Microelectronics Corporation. Other brand names and trademarks are the properties and registered brands of their respective owners.

Table of Contents

Disclaimers.....	ii
Safety Approvals.....	iii
Safety Precautions.....	iv
CHAPTER 1 INTRODUCTION	1
1.1 General Description.....	1
1.2 System Specifications.....	2
1.2.1 Main CPU Board.....	2
1.2.2 I/O System	2
1.3 Mechanical Assembly.....	4
1.3.1 Dimensions.....	4
1.3.2 I/O outlet	5
1.3.3 Mechanical Specifications	6
1.3.4 Reference Design	11
1.4 Package List.....	12
CHAPTER 2 HARDWARE INSTALLATION	13
2.1 Storage, DRAM,Wireless & 3G module Installation.....	13
2.2 Pluggable Module Method.....	23
CHAPTER 3 CONNECTORS	25
3.1 Connectors.....	25
3.1.1 JAE TX25 Connector (CN1).....	27
3.1.2 Mini Card Slot (CN3).....	28
3.1.3 Sim Slot (CN4).....	28
3.1.4 USB2.0 Port9 (CN6)	28
3.1.5 Power Button(CN7).....	29

3.1.6	HDMI Connector (CN8).....	30
3.1.7	Reset Button (CN9).....	30
3.1.8	CPU FAN (CN12).....	30
3.1.9	mSATA Slot (SCN2).....	31
3.1.10	Mini Card Slot 2 Connector(SCN4).....	32
3.1.11	Audio Mic-In Connector(SCN5).....	32
3.1.12	Audio Line-Out Connector (SCN6).....	33
3.1.13	Battery 2 Pin (BAT1).....	33
3.1.14	ATX Auto Power ON/ Clear CMOS (SSW1-Pin4).....	33
3.1.15	RJ45 (I217LM) (LAN1).....	34
3.1.16	USB Port 0/1 (USB1).....	34
3.1.17	COM Port (COM2).....	35
3.1.18	Power LED.....	35
3.1.19	HDD Activity LED.....	35
CHAPTER 4 DRIVERS INSTALLATION		37
4.1	System.....	37
CHAPTER 5 AMI BIOS SETUP UTILITY.....		39
5.1	Starting.....	39
5.2	Navigation Keys.....	39
5.3	Main Menu	40
5.4	Advanced Menu	41
5.5	Chipset Menu	51
5.6	Boot Menu	56
5.7	Security Menu	57
5.8	Save & Exit Menu.....	58
APPENDIX A REFERENCE DOCUMENTS.....		61

APPENDIX B WATCHDOG TIMER	63
APPENDIX C INTEL® RAPID STORAGE TECHNOLOGY	65

This page is intentionally left blank.

CHAPTER 1

INTRODUCTION

This chapter contains general information and detailed specifications of the OPS880-HM series. Chapter 1 includes the following sections:

- **General Description**
- **Specification**
- **Dimensions**
- **I/O Outlets**
- **Package List**

1.1 General Description

Intel Open Pluggable Specification (OPS) Compliance

OPS880-HM series is based on the 4th generation Intel® Core™ processor on board with Mobile Intel® 8 Series Express Chipset platform and also future products. The Pluggable Module is targeted to provide an interchangeable solution to the digital signage media players with compatible connector. This document provides the module form factor, connector specification, reference thermal solution, and boundary conditions in order to ensure the functionality of the module in all compatible display panel system.

OPS880-HM series meets Intel Open Pluggable Specification for design and development, simplifying system upgrade maintenance for manufacturers and developers that supports not only Intel® 4th Generation Core i family , which is high flexible and user-friendly digital signage applications.

Easy maintenance

OPS880-HM series offers a best solution for digital signage market. Compliant with Intel OPS architecture, digital signage players are capable of deploying interchangeable systems faster and easing upgrading/maintenance, while lowering costs for development and implementation. Additionally, having the ability to simply slot-in and out the unique pluggable engine box makes daily hassle easier and faster for users.

OPS880-HM series has pluggable engine box design; you can change storage, DRAM and update configurations more easily

1.2 System Specifications

1.2.1 Main CPU Board

- **CPU**
 - The OPS880-HM series has four reference solutions as BGA type with 4th generation Intel® Core™ i3/i5 Processor onboard
- **System Chipset**
 - Intel® HM86 PCH
- **BIOS**
 - AMI® BIOS
- **System Memory**
 - One socket 204-pin DDR3L SODIMM 1600 system memory up to 8GB

Caution: please note the system memory supports DDR3L type (1.35V)

- **Wireless Module (Optional)**
 - Optional IEEE802.11 b/g/n, Bluetooth 2.0

1.2.2 I/O System

- **Standard I/O**
 - One HDMI
 - Two USB ports 3.0
 - One USB ports 2.0
 - One RS-232
 - One Power on /Off button
 - One Reset button
- **Ethernet**
 - 10/100/1000Mbps Ethernet
- **Audio**
 - Line-out/ Mic-in
- **Expansion**
 - Two PCI Express Mini Card slot is equipped for optional add on such as wireless LAN card (802.11 b/g/n connections, GPS, Bluetooth)
- **Storage**
 - One PCI Express Mini Card slot is equipped for mSATA
- **Net Weight**
 - 0.9Kg(1.99 lb) without cooler

- **Dimension (Main Body Size)**
 - 200 mm x 119 mm(D) x 30 mm(H)
- **Operation Temperature**
 - 0°C to 45°C (with airflow 1.2 m/s)



NOTE: All specifications and images are subject to change without notice.

1.3 Mechanical Assembly

1.3.1 Dimensions

This diagram shows you dimensions and outlines of the OPS880-HM series

The overall dimension of the module including the mounting frame is 200mm x 119mm x 30mm and also shows the location of the front panel screw holes as well as the security lock.

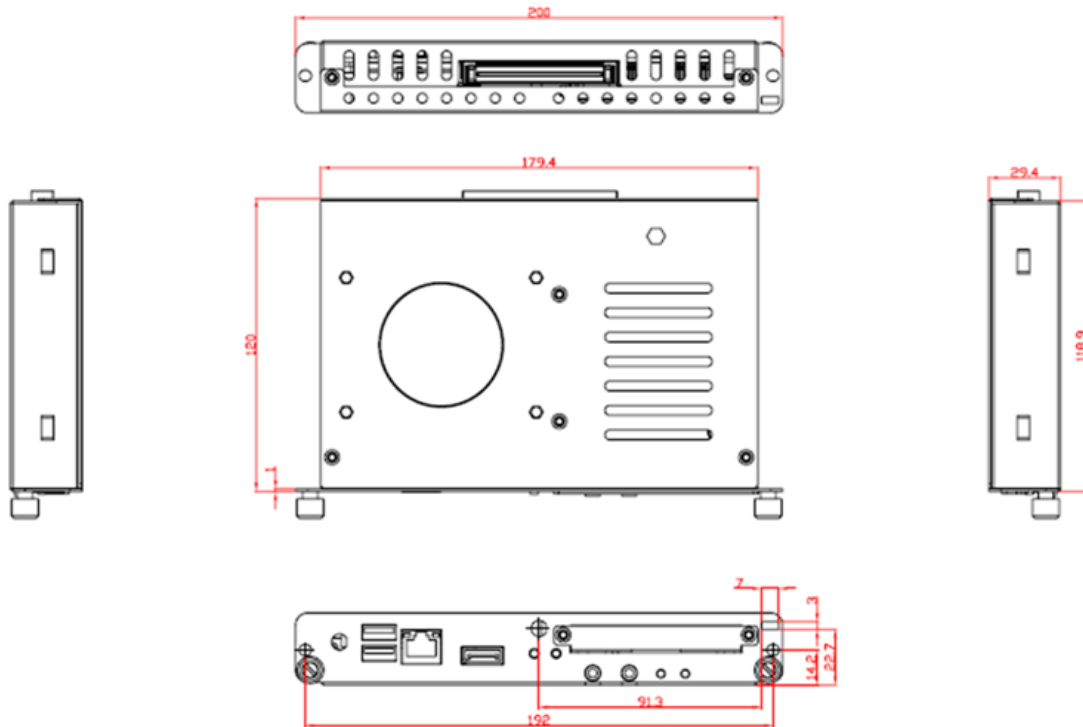

While plugging the OPS module, please make sure the heat sink side of OPS module toward the outside. Axiomtek will be out of reasonability if there is any damage occurred due to it.

1.3.2 I/O outlet

The following figures show you the locations of the OPS880-HM series I/O outlets.

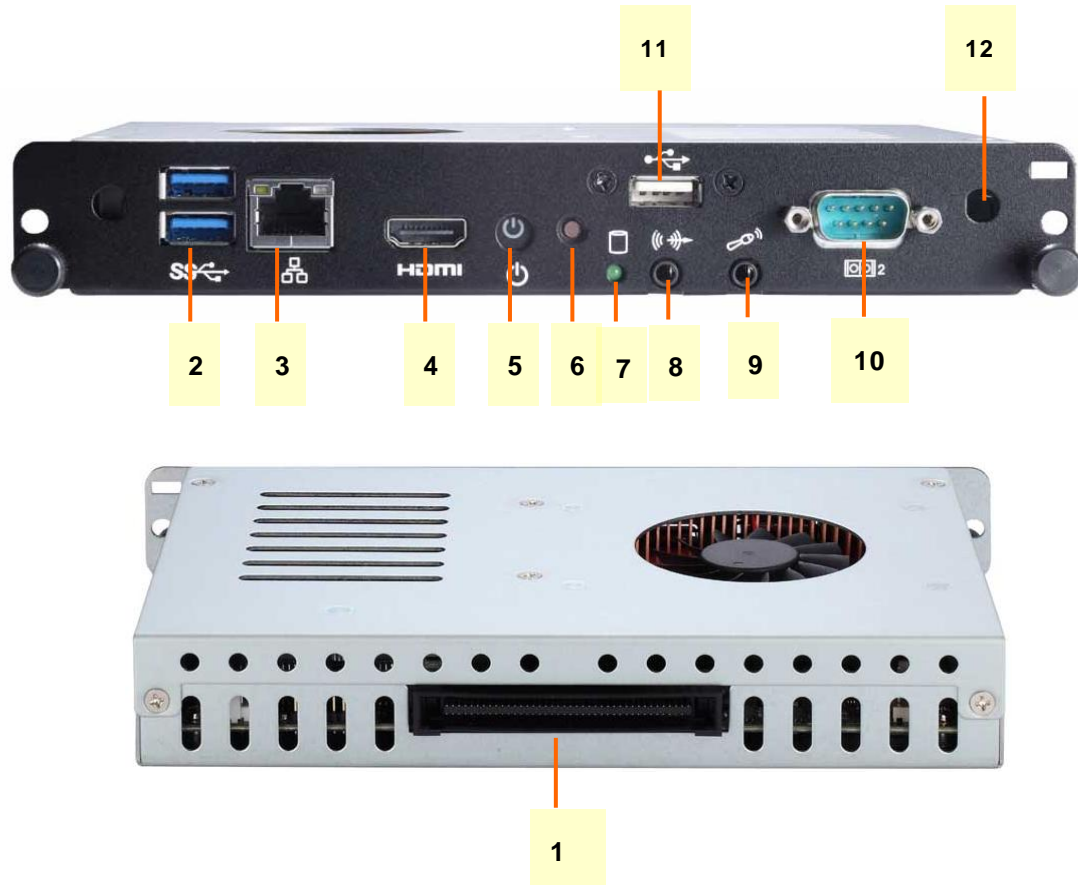

No.	Connector	No.	Connector
1	JAE TX-25	7	HDD indicator
2	USB 3.0 x2	8	Audio(Line-out)
3	Ethernet	9	Audio(Mic.-in)
4	HDMI Output	10	RS-232
5	Power Switch	11	USB 2.0
6	Reset	12	Optional Antenna

1.3.3 Mechanical Specifications

OPS880-HM series is docked in the reference display panel

The OPS880-HM Pluggable Module docked at a display panel system.

In this reference design, the module is docked and undocked in the vertical direction.



NOTE: Please contact Axiomtek for available option display panel.

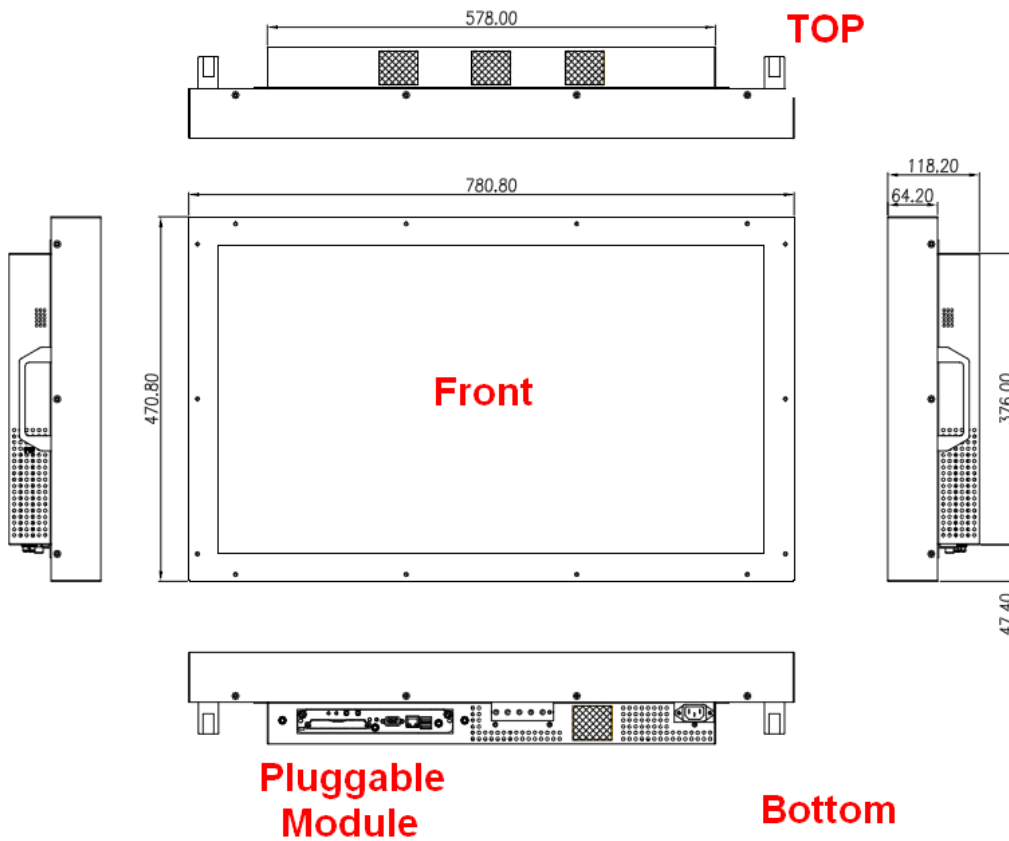

Exploded View of the Pluggable Module

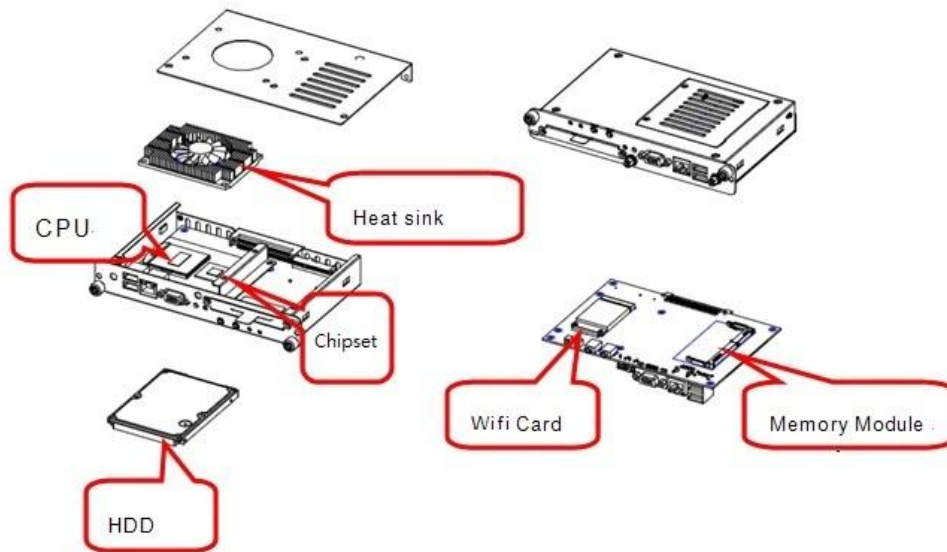

The Guide Rail Mechanism for the OPS880-HM series Module

You can use the rails alongside of OPS880-HM series Module to dock and undock the plug connector at the back of the module to connect with docking board. There are two lock pins on each side of the rail which serve as the locking mechanism to attach the lock holes on the series module.

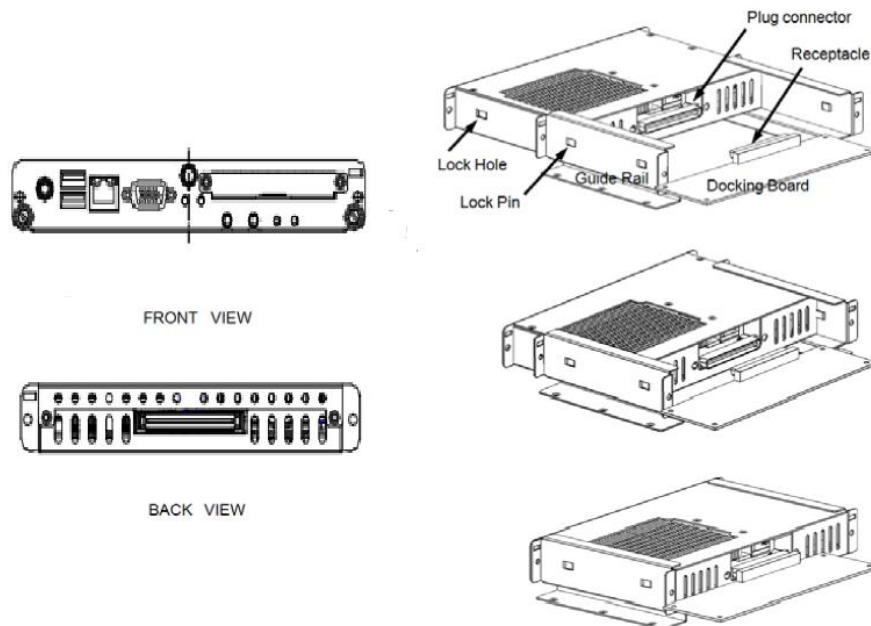

Location of Lock Hole on the Pluggable Module

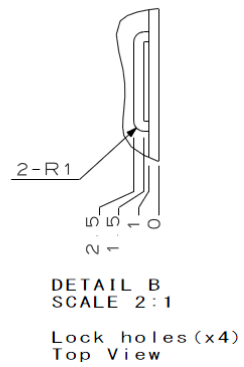
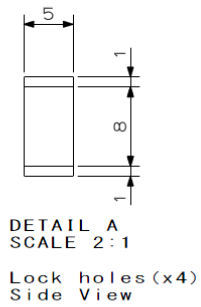
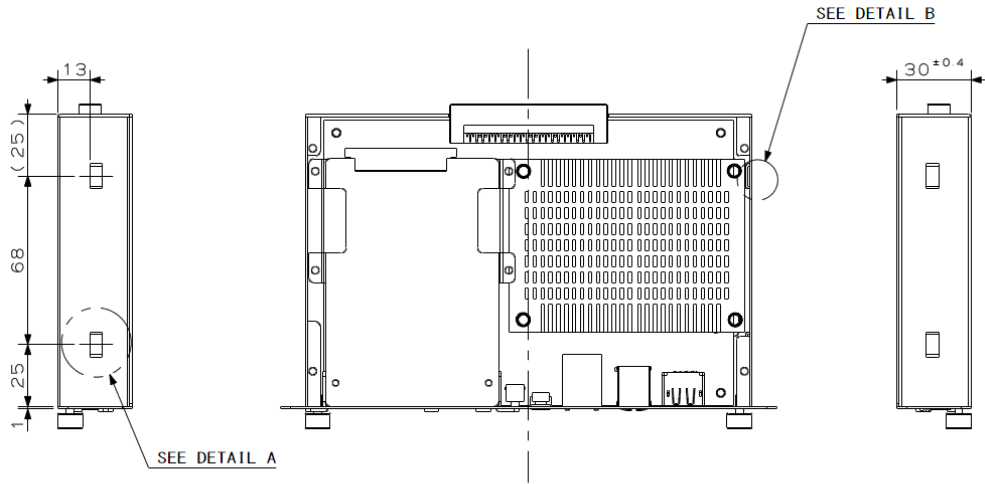

*The drawing is base on Intel Open Pluggable Specification

Dimensions of the Guide Rail

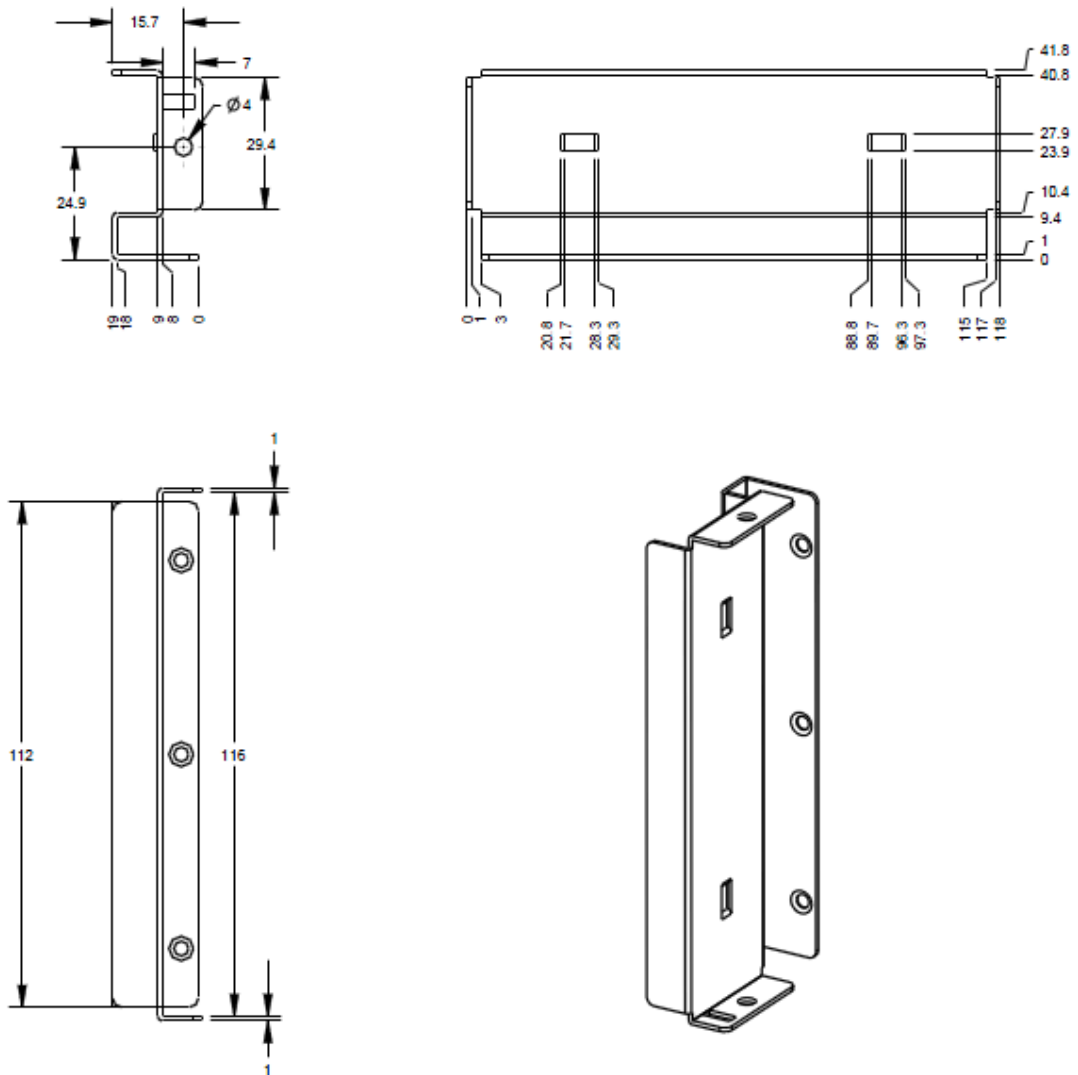

Location of JAE TX25 Plug Connector

Please refer to the following drawing for location of the JAE TX25 plug connector. Pin 1 of the connector is located at 114.8 mm from the edge of the module, and 106.9 mm from the inner side of the front panel. For mating tolerance of TX25 plug connector and TX24 receptacle connector, please refer to the JAE specification

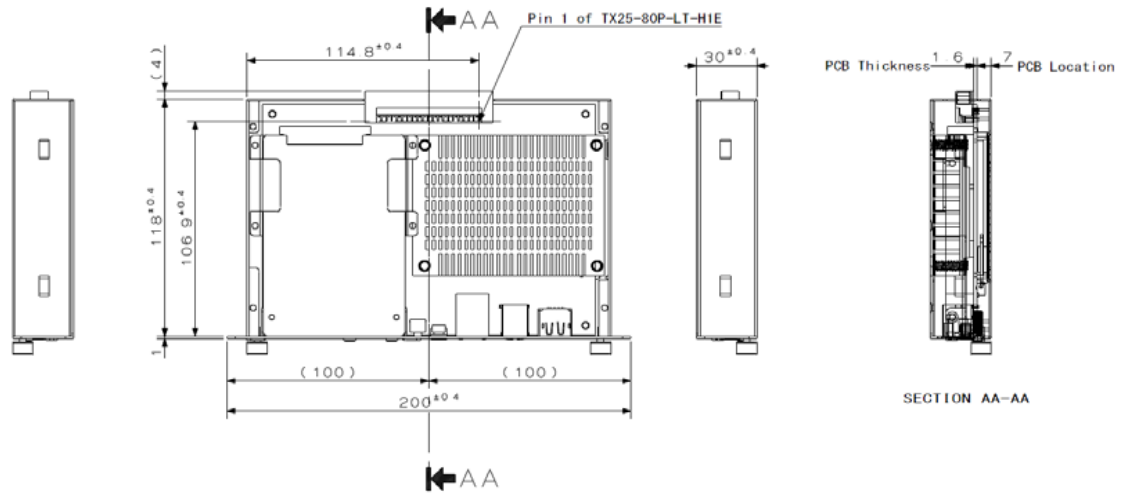

Vent Holes at the Pluggable Module Back Panel

On the OPS880-HM series module, it is recommended by Intel that some vent holes be opened at the back so that hot air can escape more easily from the module that the FAR in on both sides of the module back panel should be greater than 0.25.

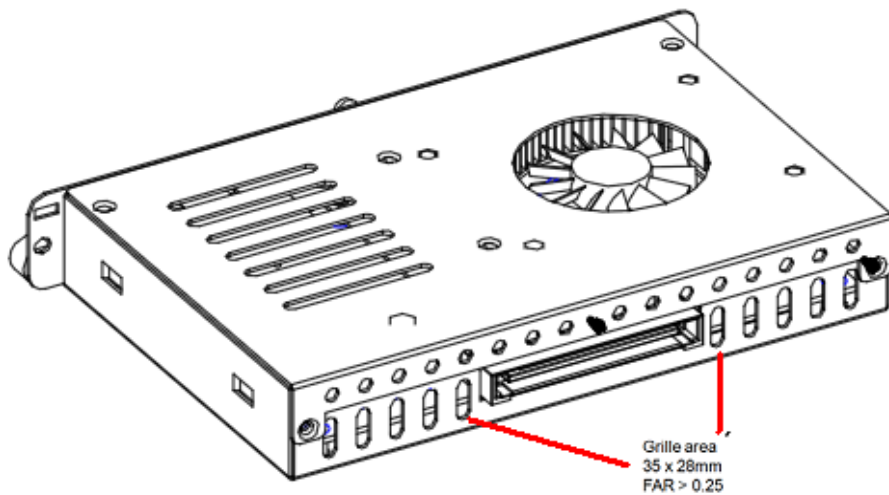

1.3.4 Reference Design

Display Panel Rear View – Internal

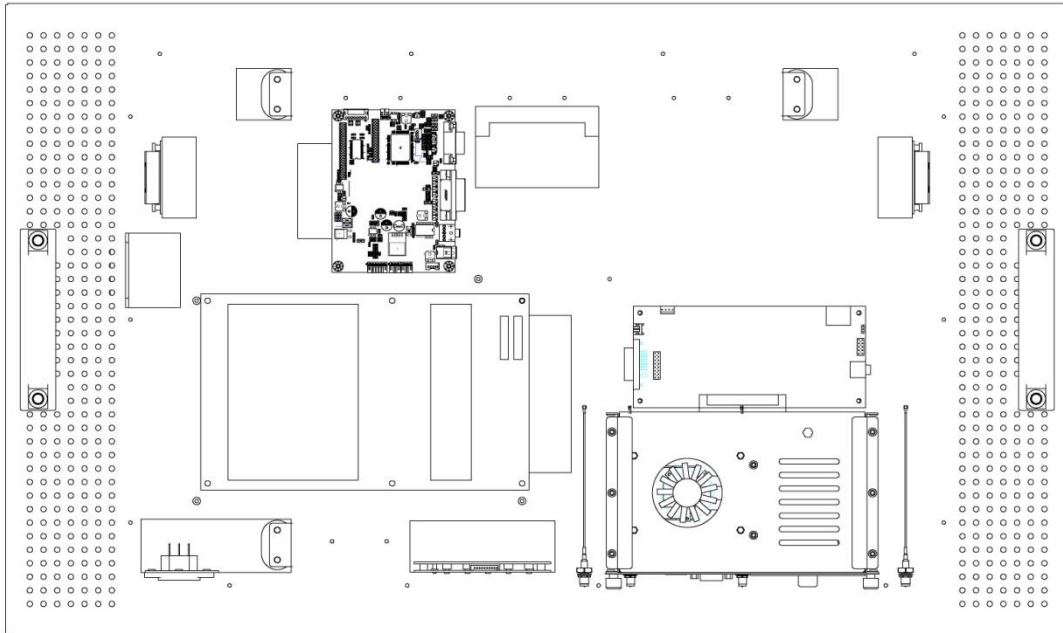

The digital signage OPS880-HM series prototype is based on a 32" display panel with the functional blocks illustrated. It is mainly a 3-board partitioning design consisting of the pluggable module, docking board and the panel control board.

1.4 Package List

When you receive the OPS880-HM series, the bundled package should contain the following items:

- **OPS880-HM device x 1**
- **CD x 1**
- **THERMAL GREASE(Syringe 1G)**
- **M2 x 5 screw x 2**
- **M4 x 6 screw x 2**

If you cannot find the package or any items are missing, please contact Axiomtek distributors immediately.

CHAPTER 2 HARDWARE INSTALLATION

The OPS880-HM series is convenient for your various hardware configurations, such as Storage, Memory Module.

The chapter 2 will show you how to install the hardware. It includes:

- **Storage, DRAM, Wireless & 3G module Installation**
- **Pluggable Module Method**

2.1 Storage, DRAM, Wireless & 3G module Installation

The OPS880-HM series model offers a convenient drive bay module for users to install Storage, DRAM, wireless & 3G module. Please follow the steps:

Step 1 Turn off the system, Loosen the screws as illustrated.

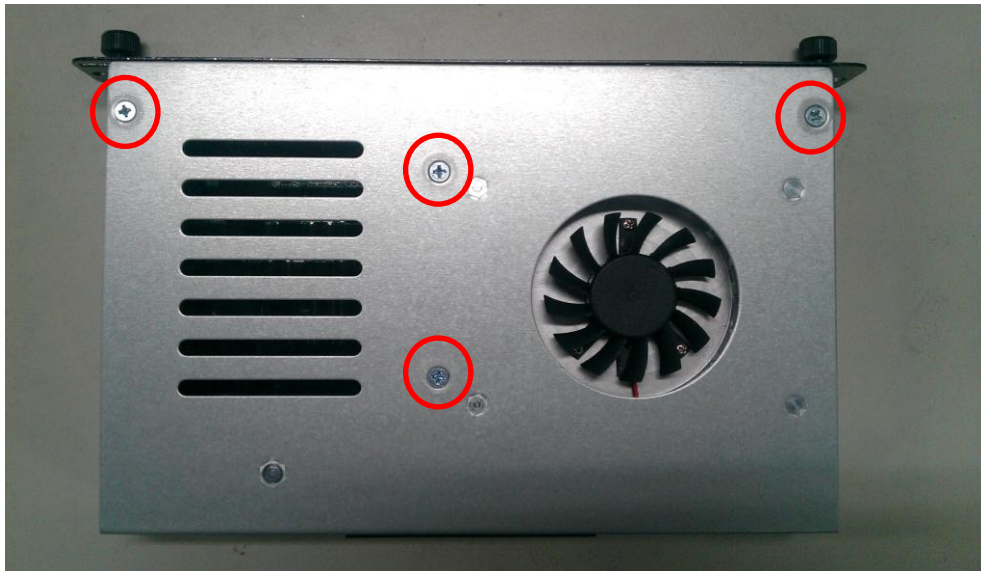

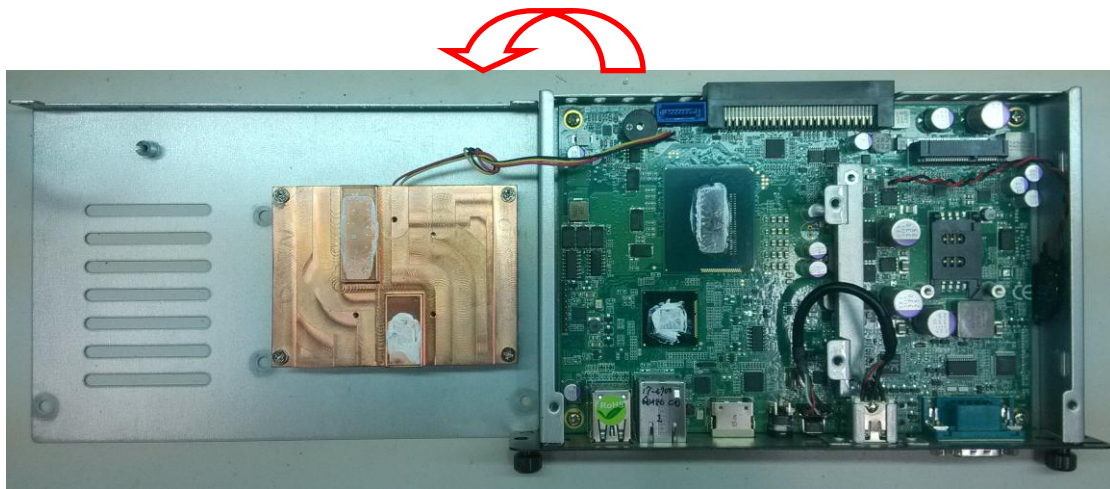

 **NOTE:** Please pull out power cable of system fan while installation

Step 2 Install DRAM

Loosen the screws on the rear of chassis as illustrated.



After losing the screws, extract the rear of chassis out of the module.



Install DRAM module.

Put DRAM. Place the memory module into the socket and press it firmly. The socket latches are levered upwards and clipped on to the edges of the DIMM.



Step 3 Install mSATA

The OPS880-HM series provides one Mini card slot for user to install mSATA. When please refer to the following instructions and illustration

Loosen the screws per illustrated.

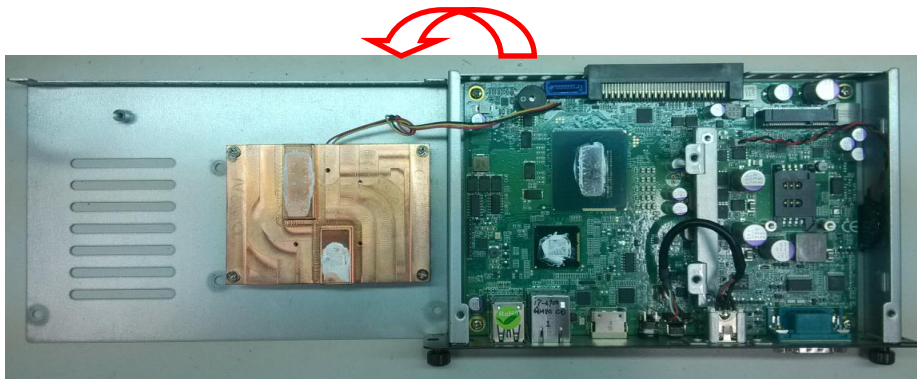

Please loosen the screws of the chassis and PCB board. Turn over the PCB board

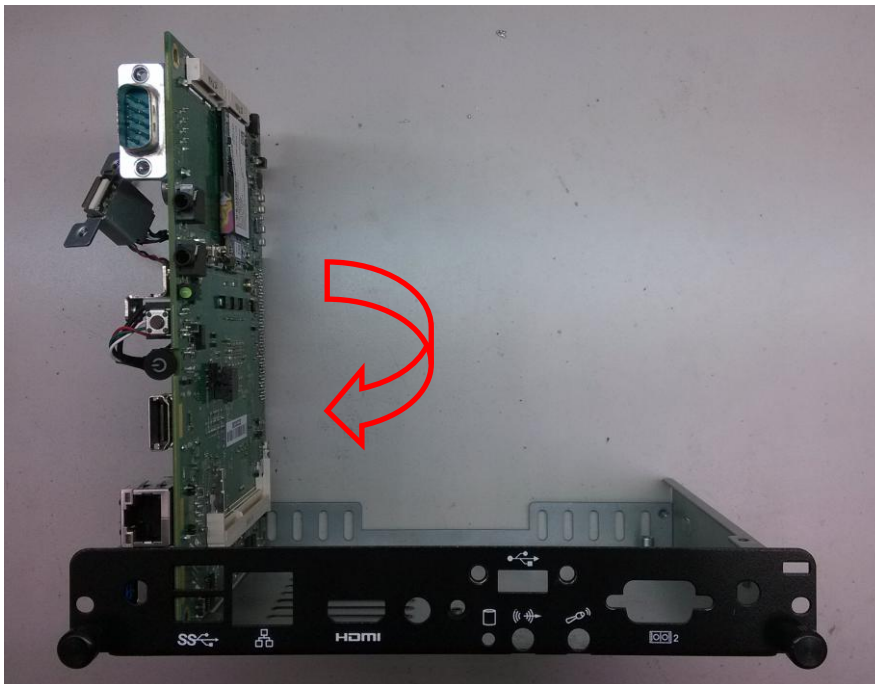

Install mSATA module. Place the mSATA module into the socket and press it firmly down until it is fully located.

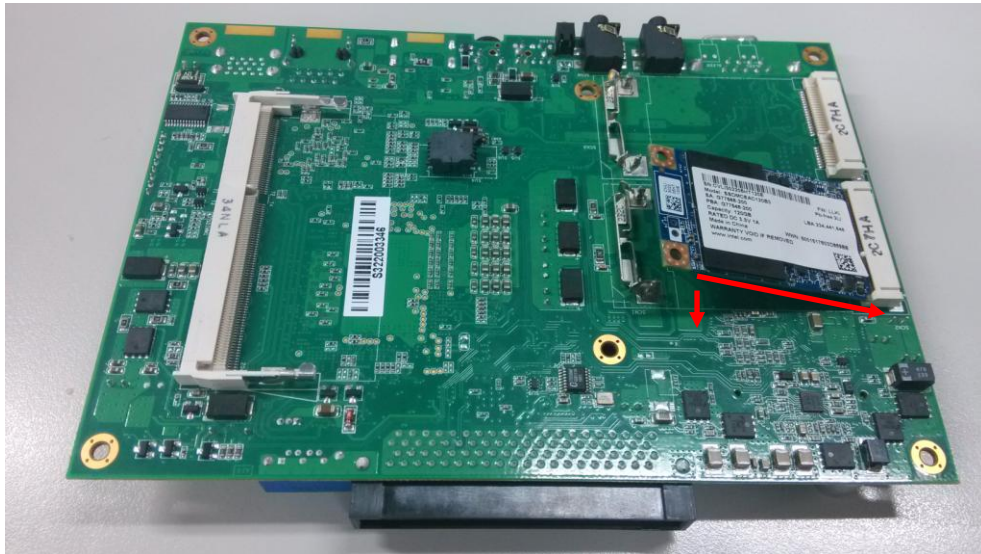

Step 4 Install Wireless Modules

The OPS880-HM series provides two Mini card slot for user to install one wireless LAN card. When installing the wireless LAN card, refer to the following instructions and illustration

Please refer to loosen the screws of the chassis and PCB board. Turn over the PCB board

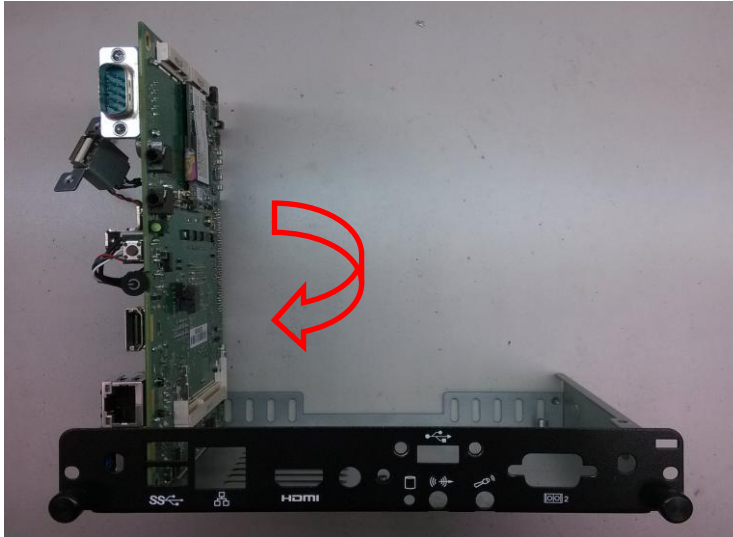

Find the Antenna cable and connect it wireless LAN card.

Screw the antenna connector at expansion I/O side and Install the antenna on the wireless LAN card

The wireless Module with one antenna application:

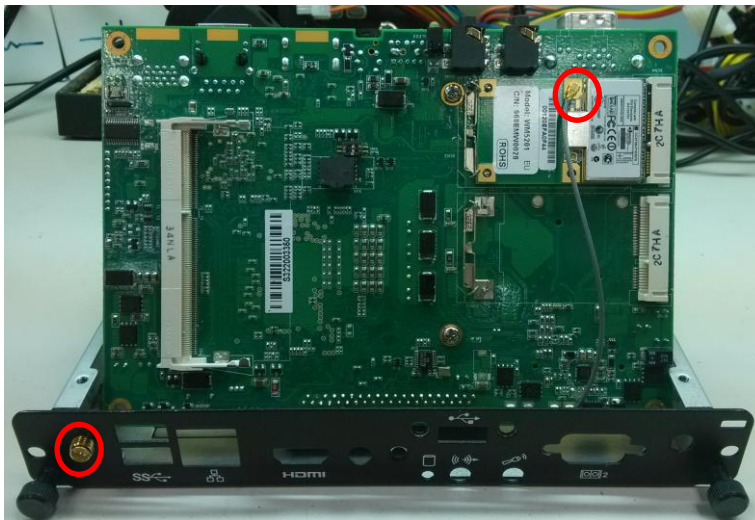

The wireless Module with two antennas application:

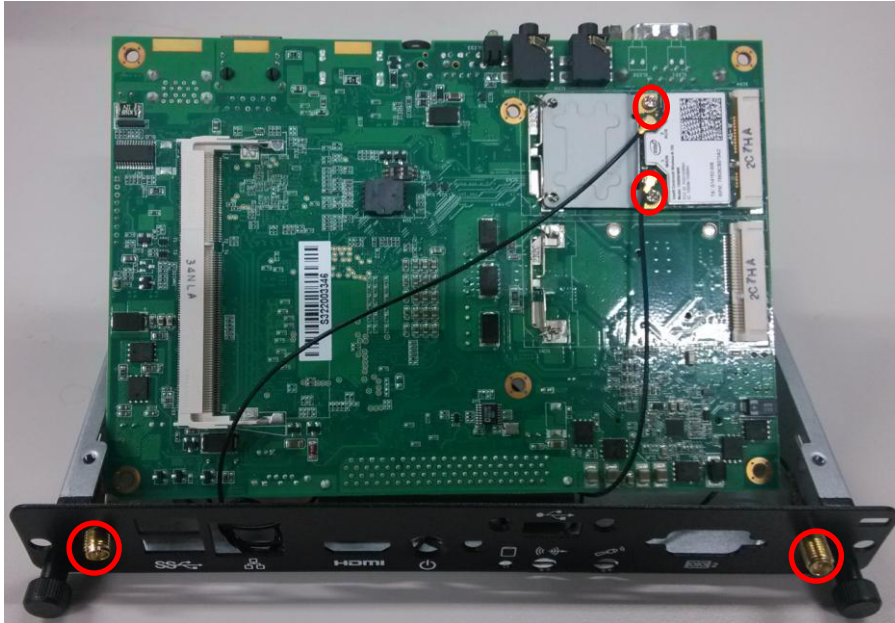

Step 5 Install 3G module

The OPS880-HM series provides one Mini card slot for user to install one 3G module. When installing the 3G module, refer to the following instructions and illustration

Please loosen the screws of the chassis and PCB board. Turn over the PCB board

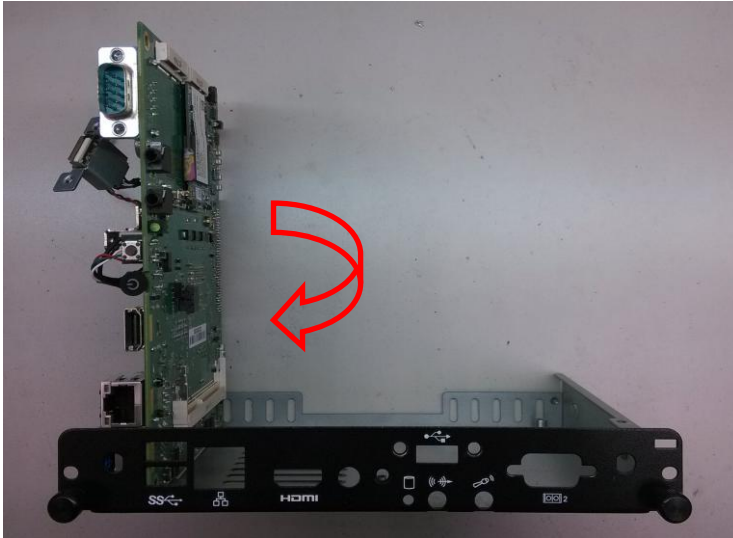

Install SIM Card module. Place the SIM Card module into the socket and press it firmly down until it is fully located.



Install 3G module. Place the 3G module into the socket and press it firmly down until it is fully located.



Affix the screws per illustrated





NOTE: You may also install wireless LAN card at this socket

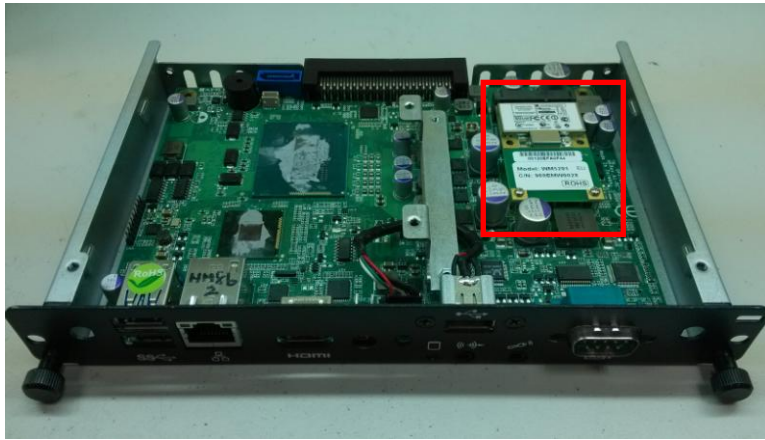

2.2 Pluggable Module Method



NOTE: Please contact Axiomtek for the available option display

Step 1 Pluggable the box into display



Caution: When plugging OPS880-HM into an OPS display, make sure the module's heat sink is facing outside of the display. Axiomtek is not responsible for any damage caused by wrong installation.

Step 2 Fasten the screws as illustrated



This page is intentionally left blank.

CHAPTER 3 CONNECTORS

This chapter provides users with detailed description how to set up basic system configuration through the AMIBIOS8 BIOS setup utility.

3.1 Connectors

Connectors connect this board with other parts of the system. Loose or improper connection might cause problems. Make sure all connectors are properly and firmly connected.

Here is a summary table shows you all connectors on the board.

Connector	Label
JAE TX25 Connector	CN1
Mini Card Slot 1	CN3
SIM Card Slot	CN4
USB2.0 Port 9(USB Cable)	CN6
POWER BUTTON +LED	CN7
HDMI	CN8
RESET BUTTON	CN9
CPU FAN	CN12
m-SATA Slot	SCN2
Mini Card Slot 2	SCN4
Audio MIC-IN Connector	SCN5
Audio LINE-OUT Connector	SCN6
Battery 2 PIN	BAT1
ATX Auto Power On (SSW1 1&4)	SSW1
Clear CMOS (SSW1 2&3)	
DDR3L Memory Slot	SDIMM1
RJ45 (I217LM)	LAN1
USB3.0/2.0 Port	USB1
COM Port	COM2
HDD LED	SLED3

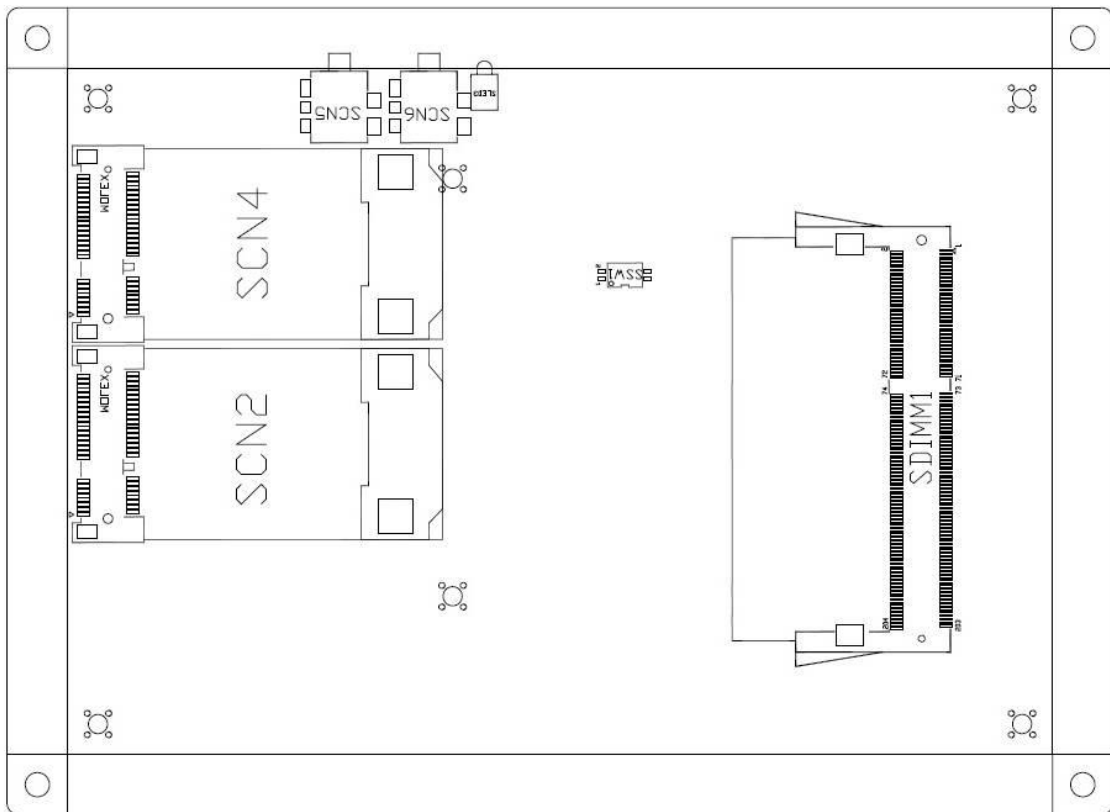
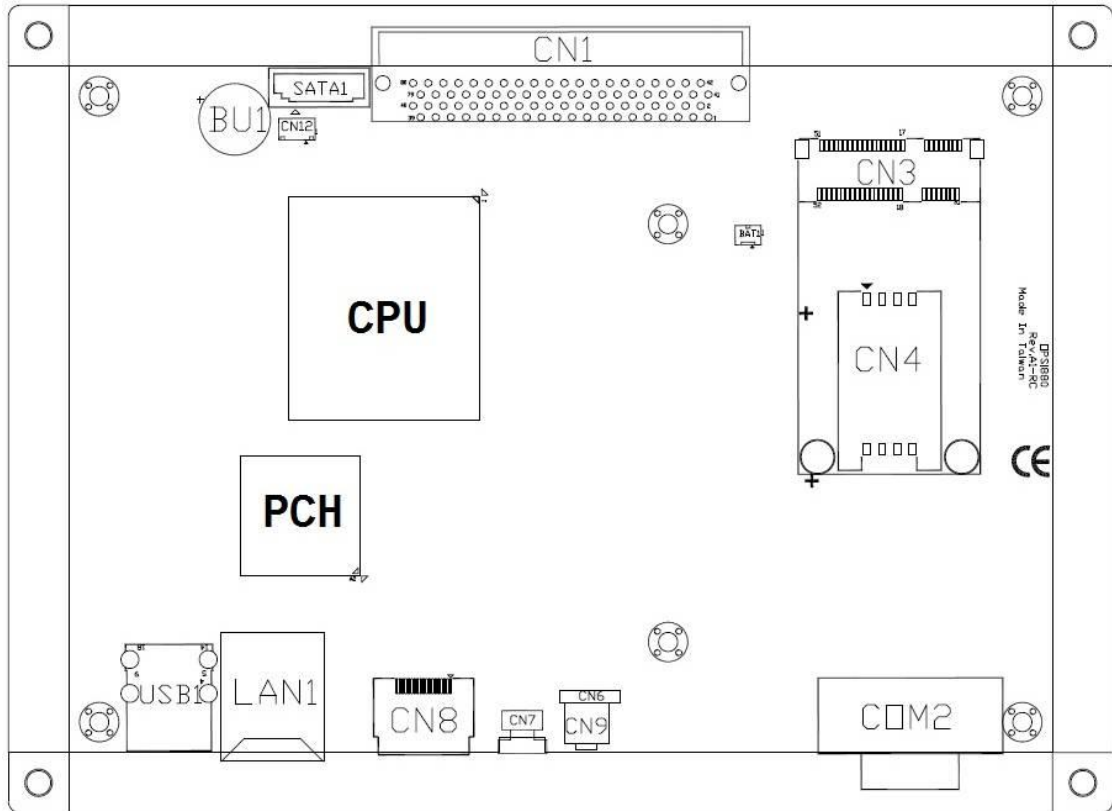

3.1.1 JAE TX25 Connector (CN1)

Connector JAE TX25 CN1 is for JAE interface support.

Pin	Signal	Pin	Signal	Pin	Signal	Pin	Signal
1	DDP_3N	2	DDP_3P	3	GND	4	DDP_2N
5	DDP_2P	6	GND	7	DDP_1N	8	DDP_1P
9	GND	10	DDP_0N	11	DDP_0P	12	GND
13	DDP_AUXN	14	DDP_AUXP	15	DDP_HPDP	16	GND
17	TMDS_CLK-	18	TMDS_CLK+	19	GND	20	TMDS0-
21	TMDS0+	22	GND	23	TMDS1-	24	TMDS1+
25	GND	26	TMDS2-	27	TMDS2+	28	GND
29	DVI_DDC_DATA	30	DVI_DDC_CLK	31	DVI_HPDP	32	GND
33	+12V~+19V	34	+12V~+19V	35	+12V~+19V	36	+12V~+19V
37	+12V~+19V	38	+12V~+19V	39	+12V~+19V	40	+12V~+19V
41	RSVD	42	RSVD	43	RSVD	44	RSVD
45	RSVD	46	RSVD	47	RSVD	48	RSVD
49	SLP_S3	50	SYS_FAN	51	UART_RXD	52	UART_TXD
53	GND	54	StdA_SSRX-	55	StdA_SSRX+	56	GND
57	StdA_SSTX-	58	StdA_SSTX+	59	GND	60	USB_PN2
61	USB_PP2	62	GND	63	USB_PN1	64	USB_PP1
65	GND	66	USB_PN0	67	USB_PP0	68	GND
69	AZ_LINEOUT_L	70	AZ_LINEOUT_R	71	NC	72	PB_DET
73	PS_ON#	74	PWR_STATUS	75	GND	76	GND
77	GND	78	GND	79	GND	80	GND

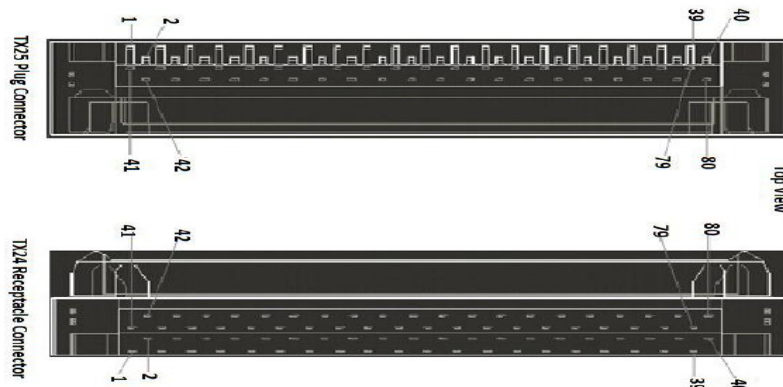

3.1.2 Mini Card Slot (CN3)

Pin	Signal	Pin	Signal	Pin	Signal
1	WAKE#	2	+3.3VAUX	3	RVD1
4	GND	5	RVD2	6	+1.5V
7	CLKREQ#	8	SIM Card_Power	9	GND
10	SIM Card_I/O	11	REFCLK-	12	SIM Card_CLK
13	REFCLK+	14	SIM Card_RST-	15	GND
16	SIM Card_VPP	17	RVD3	18	GND
19	RVD4	20	+3.3VAUX	21	GND
22	PERST#	23	PERN0	24	+3.3VAUX
25	PERP0	26	GND	27	GND
28	+1.5V	29	GND	30	SMB_CLK
31	PETN0	32	SMB_DATA	33	PETP0
34	GND	35	GND	36	USB_D-
37	RVD5	38	USB_D+	39	+3.3VAUX
40	GND	41	+3.3VAUX	42	LED_WWAN#
43	RVD8	44	LED_WLAN#	45	RVD9
46	LED_WPAN#	47	RVD10	48	+1.5V
49	RVD11	50	GND	51	RVD12
52	+3.3VAUX	53	NH1	54	NH2
55	NH3	56	NH4		

3.1.3 Sim Slot (CN4)

Pin	Signal
1	SIM_PWR
2	SIM_RESET
3	SIM_CLK
4	NC
5	GND
6	SIM_DATA
7	SIM_I/O
8	NC

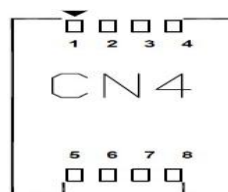

3.1.4 USB2.0 Port9 (CN6)

Pin	Signal
1	+5V

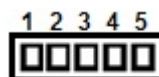

2	USB D-
3	USB D+
4	GND
5	GND

3.1.5 Power Button(CN7)

Pin	Signal
1	PWRBTN-
2	PWRBTN-
3	GND
4	GND
5	5VSB
6	+5V

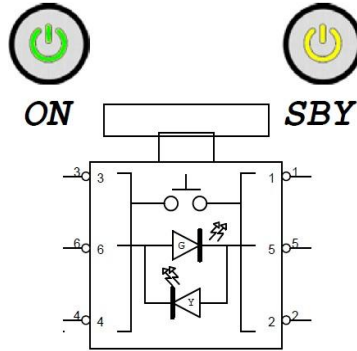

3.1.6 HDMI Connector (CN8)

The HDMI (High-Definition Multimedia Interface) is a compact digital interface which is capable of transmitting high-definition video and high-resolution audio over a single cable. Its interface is available through connector CN8.

Pin	Signal	Pin	Signal
1	HDMI OUT_DATA2+	2	GND
3	HDMI OUT_DATA2-	4	HDMI OUT_DATA1+
5	GND	6	HDMI OUT_DATA1-
7	HDMI OUT_DATA0+	8	GND
9	HDMI OUT_DATA0-	10	HDMI OUT Clock+
11	GND	12	HDMI OUT Clock-
13	N.C.	14	N.C.
15	HDMI OUT_SCL	16	HDMI OUT_SDA
17	GND	18	+5V
19	HDMI_HTPLG		

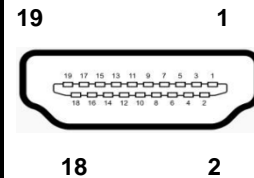

3.1.7 Reset Button (CN9)

CN9 is the reset switch that reboots your computer instead of turning OFF the power switch. It is a better way to reboot your system for a longer life of the system's power supply.

Pin	Signal
1	RST-
2	GND
3	GND
4	GND

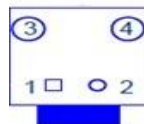

3.1.8 CPU FAN (CN12)

Pin	Signal
1	GND
2	FAN CTRL
3	VCC

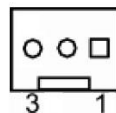

3.1.9 mSATA Slot (SCN2)

Pin	Signal	Pin	Signal	Pin	Signal	Pin	Signal
1	NC	2	+3.3VAUX	3	RVD1	4	GND
5	RVD2	6	+1.5V	7	CLKREQ#	8	RVD19
9	GND	10	RVD18	11	REFCLK	12	RVD16
13	REFCLK+	14	RVD15	15	GND	16	RVD14
17	RVD3	18	GND	19	RVD4	20	+3.3VAUX
21	GND	22	PERST#	23	m-SATA RXP	24	+3.3VAUX
25	m-SATA RXN	26	GND	27	GND	28	+1.5V
29	GND	30	SMB_CLK	31	m-SATA TXN	32	SMB_DATA
33	m-SATA TXP	34	GND	35	GND	36	USB_D-
37	RVD5	38	USB_D+	39	+3.3VAUX	40	GND
41	+3.3VAUX	42	NC	43	RVD8	44	NC
45	RVD9	46	NC	47	RVD10	48	+1.5V
49	RVD11	50	GND	51	RVD12	52	+3.3VAUX
53	NH1	54	NH2	55	NH3	56	NH4

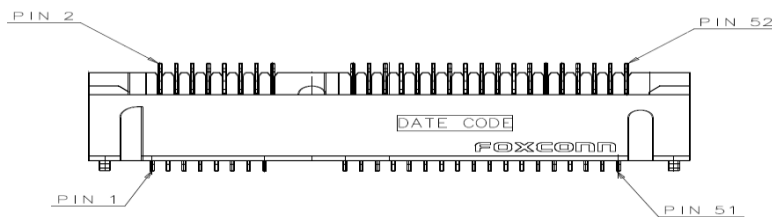

3.1.10 Mini Card Slot 2 Connector(SCN4)

Pin	Signal	Pin	Signal	Pin	Signal	Pin	Signal
1	WAKE#	2	+3.3VAUX	3	RVD1	4	GND
5	RVD2	6	+1.5V	7	CLKREQ#	8	RVD19
9	GND	10	RVD18	11	REFCLK-	12	RVD16
13	REFCLK+	14	RVD15	15	GND	16	RVD14
17	RVD3	18	GND	19	RVD4	20	+3.3VAUX
21	GND	22	PERST#	23	PERN0	24	+3.3VAUX
25	PERP0	26	GND	27	GND	28	+1.5V
29	GND	30	SMB_CLK	31	PETN0	32	SMB_DATA
33	PETP0	34	GND	35	GND	36	USB_D-
37	RVD5	38	USB_D+	39	+3.3VAUX	40	GND
41	+3.3VAUX	42	LED_WWAN#	43	RVD8	44	LED_WLAN#
45	RVD9	46	LED_WPAN#	47	RVD10	49	RVD11
48	+1.5V	50	GND	51	RVD12	52	+3.3VAUX
53	NH1	54	NH2	55	NH3	56	NH4

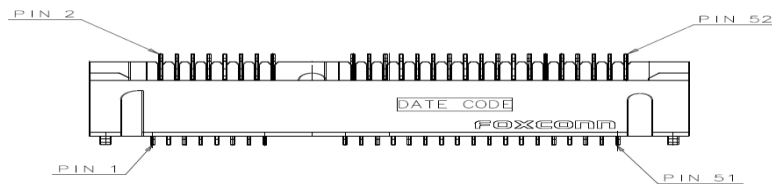

3.1.11 Audio Mic-In Connector(SCN5)

Pin	Signal
1	GND
2	MIC_IN_R
3	GND
4	MIC_IN_L
5	MIC_DETECT

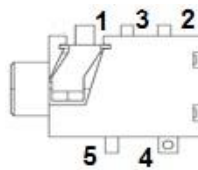

3.1.12 Audio Line-Out Connector (SCN6)

Pin	Signal
1	GND
2	LINE_OUT_R
3	GND
4	LINE_OUT_L
5	LINE_OUT_DETECT

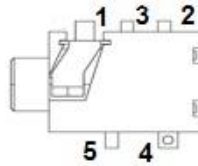

3.1.13 Battery 2 Pin (BAT1)

Pin	Signal
1	+VBAT
2	GND



3.1.14 ATX Auto Power ON/ Clear CMOS (SSW1-Pin4)

AT or ATX Select (SSW1- Pin1 & Pin4)

Description	Settings
ATX	OFF (Default)
AT	ON



Clear CMOS (SSW1- Pin2 & Pin3)

Description	Settings
Clear CMOS	OFF (Default)
Clear CMOS	ON

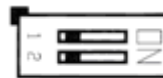

3.1.15 RJ45 (I217LM) (LAN1)

The RJ-45 connector LAN1 is for Ethernet. To connect the board to 100-Base-T or 1000-Base-T hub, just plug one end of the cable into LAN1 and connect the other end (phone jack) to a 100-Base-T hub or 1000-Base-T hub.

Pin	Signal
1	Tx+ (Data transmission positive)
2	Tx- (Data transmission negative)
3	Rx+(Data reception positive)
4	RJ-1(For 1000 base T-Only)
5	RJ-1(For 1000 base T-Only)
6	Rx- (Data reception negative)
7	RJ-1(For 1000 base T-Only)
8	RJ-1(For 1000 base T-Only)
A	Active LED
B	Speed LED

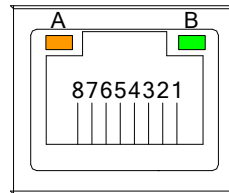

3.1.16 USB Port 0/1 (USB1)

Pin	Signal
1	USB3_POWER
2	USB D0-
3	USB D0+
4	GND
5	USB3_SSRX0-
6	USB3_SSRX0+
7	GND
8	USB3_SSTX0-
9	USB3_SSTX0+
10	USB3_POWER
11	USB D1-
12	USB D1+
13	GND
14	USB3_SSRX1-
15	USB3_SSRX1+
16	GND
17	USB3_SSTX1-
18	USB3_SSTX1+

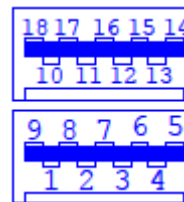

3.1.17 COM Port (COM2)

The COM Port connector is a standard DB-9 connector. The pin assignment of RS-232 is listed on the following table

Pin	Signal
1	DCD, Data carrier detect
2	RXD, Receive data
3	TXD, Transmit data
4	DTR, Data terminal ready
5	GND, ground
6	DSR, Data set ready
7	RTS, Request to send
8	CTS, Clear to send
9	RI, Ring indicator

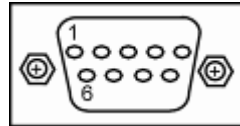

3.1.18 Power LED

The Power LED lights up when the system is powered ON.

3.1.19 HDD Activity LED

This connection is linked to hard drive activity LED on the control panel. LED flashes when HDD is being accessed

This page is intentionally left blank.

CHAPTER 4 DRIVERS INSTALLATION

4.1 System

OPS880-HM series supports Windows 7 and Windows 10. To facilitate the installation of system driver, please carefully read the instructions in this chapter before start installing.

- Insert Intel Express Installer Driver CD and select the “\Driver\”.
- Select your operating system driver to install.

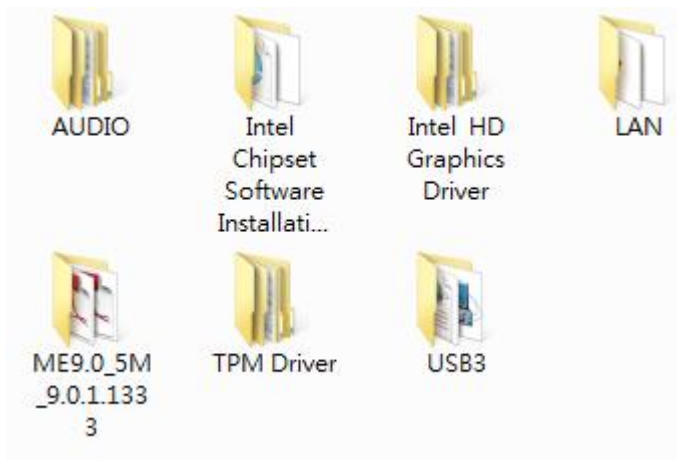

- Select all files and follow the installing procedure.



NOTE: For latest system driver for installation, you may visit Axiomtek website at www.axiomtek.com

This page is intentionally left blank.

CHAPTER 5 AMI BIOS SETUP UTILITY

This chapter provides users with detailed description how to set up basic system configuration through the AMIBIOS8 BIOS setup utility.

5.1 Starting

To enter the setup screens, follow the steps below:

- Turn on the computer and press the key immediately.
- After you press the key, the main BIOS setup menu displays. You can access the other setup screens from the main BIOS setup menu, such as the Chipset and Power menus.

5.2 Navigation Keys

The BIOS setup/utility uses a key-based navigation system called hot keys. Most of the BIOS setup utility hot keys can be used at any time during the setup navigation process.

These keys include <F1>, <F2>, <Enter>, <ESC>, <Arrow> keys, and so on.



NOTE: Some of navigation keys differ from one screen to another.

Hot Key	Description
← Left/Right	The Left <Arrow> keys allow you to select a setup screen.
↑↓ Up/Down	The Up and Down <Arrow> keys allow you to select a setup screen or sub-screen.
+– Plus/Minus	The Plus and Minus <Arrow> keys allow you to change the field value of a particular setup item.
Tab	The <Tab> key allows you to select setup fields.
F1	The <F1> key allows you to display the General Help screen.
F2	The <F2> key allows you to Load Previous Values.
F3	The <F3> key allows you to Load Optimized Defaults.
F4	The <F4> key allows you to save any changes you have made and exit Setup. Press the <F4> key to save your changes.
Esc	The <Esc> key allows you to discard any changes you have made and exit the Setup. Press the <Esc> key to exit the setup without saving your changes.
Enter	The <Enter> key allows you to display or change the setup option listed for a particular setup item. The <Enter> key can also allow you to display the setup sub- screens.

5.3 Main Menu

When you first enter the Setup Utility, you will enter the Main setup screen. You can always return to the Main setup screen by selecting the Main tab. There are two Main Setup options. They are described in this section. The Main BIOS Setup screen is shown below.

Aptio Setup Utility - Copyright (C) 2012 American Megatrends , Inc .

Main Advanced Chipset Boot Security Save & Exit

BIOS Information BIOS Version OPSi880H X002 Build Date and Time 09/16/2013 13:44:46 System Date [Fri 10/04/2013] System Time [03:11:54] Access Level Administrator	Set the Date. Use Tab to switch between Date elements. → ← : Select Screen ↑ ↓ : Select Item Enter : Select +/- : Change Opt. F1 : General Help F2 : Previous Values F3 : Optimized Defaults F4 : Save & Exit ESC : Exit
---	---

Version 2.15.1236. Copyright (C) 2012 American Megatrends, Inc .

➤ **System Date/Time**

Use this option to change the system date and time. Highlight System Date or System Time using the <Arrow> keys. Enter new values through the keyboard. Press the <Tab> key or the <Enter> keys to move between fields. The date must be entered in MM/DD/YY format. The time is entered in HH:MM:SS format.

5.4 Advanced Menu

- **Launch PXE OpROM**

Use this item to enable or disable the Boot ROM function of the onboard LAN chip when the system boots up.

The Advanced menu also allows users to set configuration of the CPU and other system devices. You can select any of the items in the left frame of the screen to go to the sub menu:

- **ACPI Settings**
- **S5 RTC Wake Settings**
- **Trusted Computing**
- **CPU Configuration**
- **SATA Configuration**
- **PCH-FW Configuration**
- **USB Configuration**
- **F81801 Super IO Configuration**
- **F81801 H/W Monitor**

For items marked with “▶”, please press <Enter> for more options.

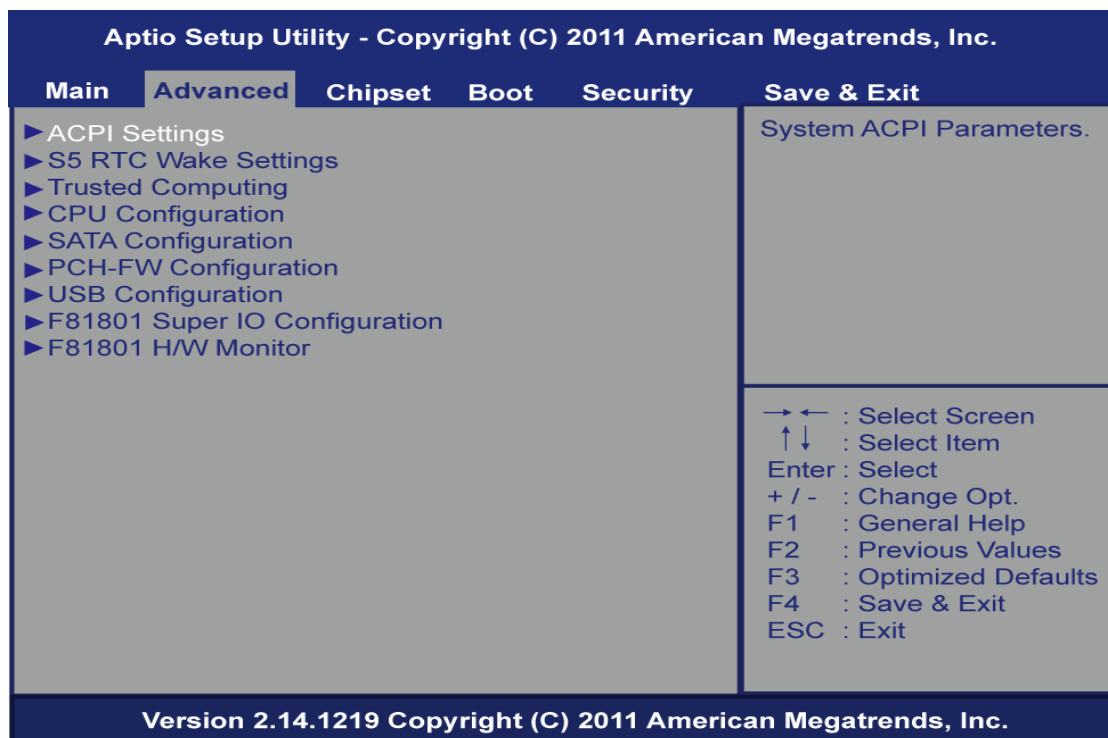

- **ACPI Settings**

You can use this screen to select options for the ACPI Configuration, and change the value of the selected option. A description of the selected item appears on the right side of the screen.

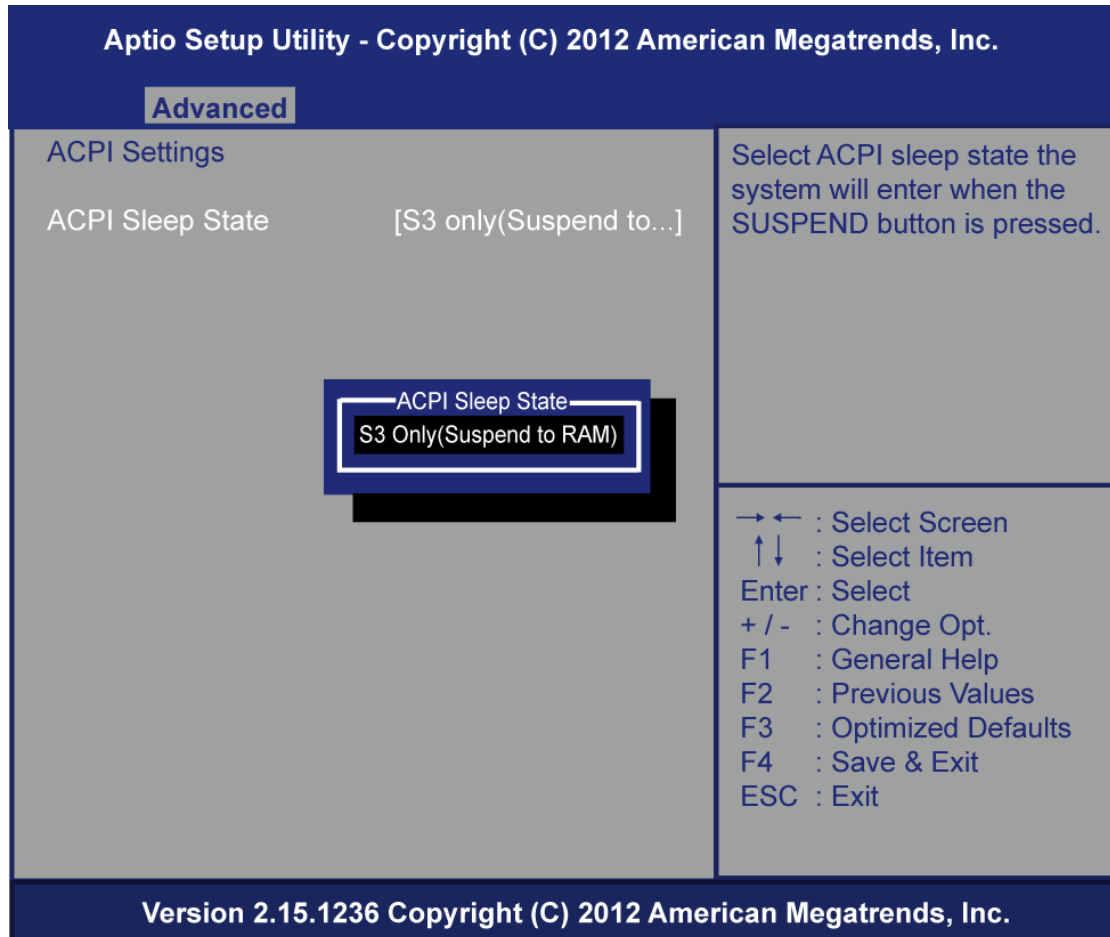

- **ACPI Sleep State**

Allow you to select the Advanced Configuration and Power Interface (ACPI) state to be used for system suspend. Here are the options for your selection, S3 (Suspend to RAM)

- **S5 RTC Wake Settings**

Enable or disable system wake on alarm event. When enabled, System will wake on the hr:min::sec specified

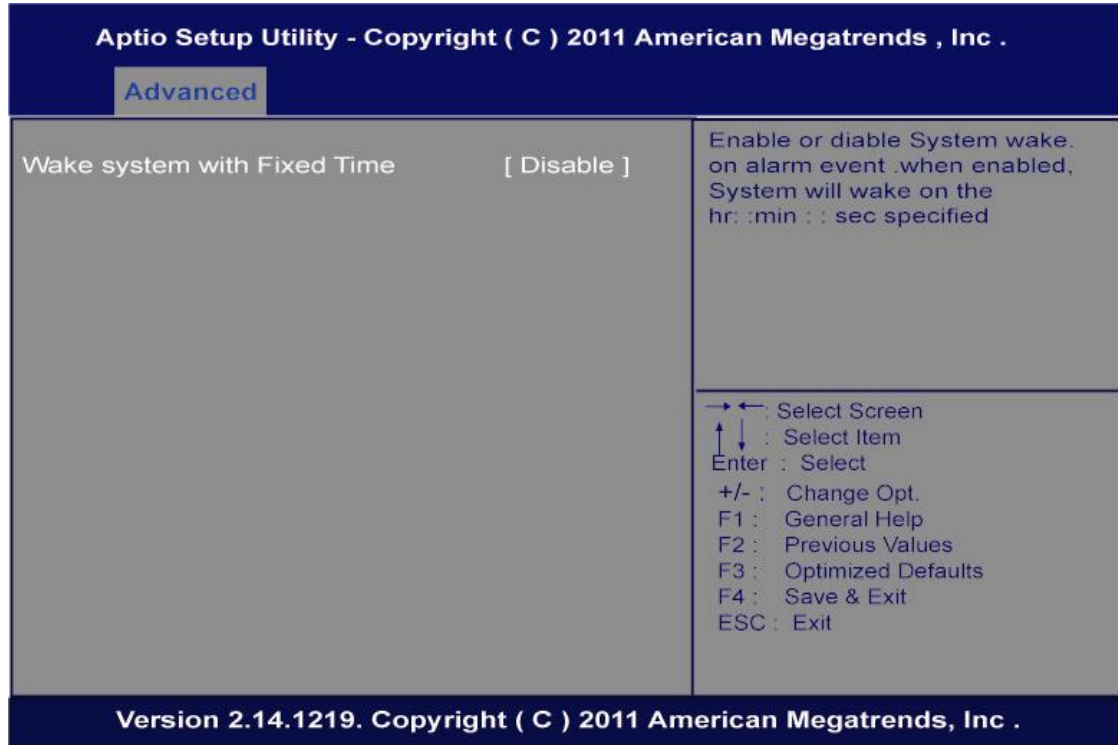

- **Trusted Computing**

Enables or disables BIOS support for security device. O.S. will not show Security Device. TCG EFI protocol and INT1A interface will not be available.

TCG EFI protocol and INT1A interface will not be available.

Aptio Setup Utility - Copyright (C) 2012 American Megatrends, Inc.	
Advanced	
<p>Configuration</p> <p>Security Device Support [Disable]</p> <p>Current Status Information</p> <p>SUPPORT TURNED OFF</p>	<p>Enables or Disables BIOS Support for security device. O.S. will not show Security Device. TCG EFI protocol and INT1A interface will not be available.</p> <hr/> <p>→ ← : Select Screen ↑ ↓ : Select Item Enter : Select + / - : Change Opt. F1 : General Help F2 : Previous Values F3 : Optimized Defaults F4 : Save & Exit ESC : Exit</p>
Version 2.15.1236 Copyright (C) 2012 American Megatrends, Inc.	

- **CPU Configuration**

This screen shows the CPU Configuration, and you can change the value of the selected option.

Aptio Setup Utility - Copyright (C) 2012 American Megatrends , Inc .

Advanced

CPU Configuration		
Intel(R) Core(TM) i7-4700EQ CPU@ 2.4GHZ		Enabled for Windows XP and Linux (OS optimized for Hyper-Threading Technology) and Disabled for other OS (OS not optimized for Hyper-Threading Technology). When Disabled only one thread per enabled core is enabled.
CPU Signature	306a9	
Microcode Patch	C	
Max CPU Speed	2400 HMz	
Min CPU Speed	600 HMz	
CPU Speed	2800 HMz	
Processor Cores	4	
Intel HT Technology	Supported	
Intel VT-x Technology	Supported	
Intel SMX Technology	Supported	
64-bit	Supported	
EIST Technology	32 KB x 4	
CPU C3 state	32 KB x 4	
CPU C6 state	256 KB x 4	
CPU C7 state	6144 KB	
L1 Data Cache	32 KB x 4	→ ← : Select Screen ↑ ↓ : Select Item Enter : Select +/- : Change Opt. F1 : General Help F2 : Previous Values F3 : Optimized Defaults F4 : Save & Exit ESC : Exit
L1 Code Cache	32 KB x 4	
L2 Cache	256 KB x 4	
L3 Cache	6144 KB	
Hyper-threading	[Enabled]	
Intel Virtualization Technology	[Enabled]	

Version 2.15.1236 Copyright (C) 2012 American Megatrends, Inc.

- **Hyper-threading**

This feature can enable /disable Intel Hyper-Threading technology

- **Intel Virtualization Technology**

Allows a hardware platform to run multiple operating systems separately and simultaneously, enabling one system to virtually function as several systems.

- **EIST**

This feature can enable /disable Enhanced Intel speed Step Technology (EIST

EIST (Enhanced Intel Speed Step Technology) allows the system to automatically adjust processor voltage and core frequency in an effort to reduce power consumption and heat dissipation

● **SATA Configuration**

You can use this screen to select options for the SATA Configuration, and change the value of the selected option. A description of the selected item appears on the right side of the screen.

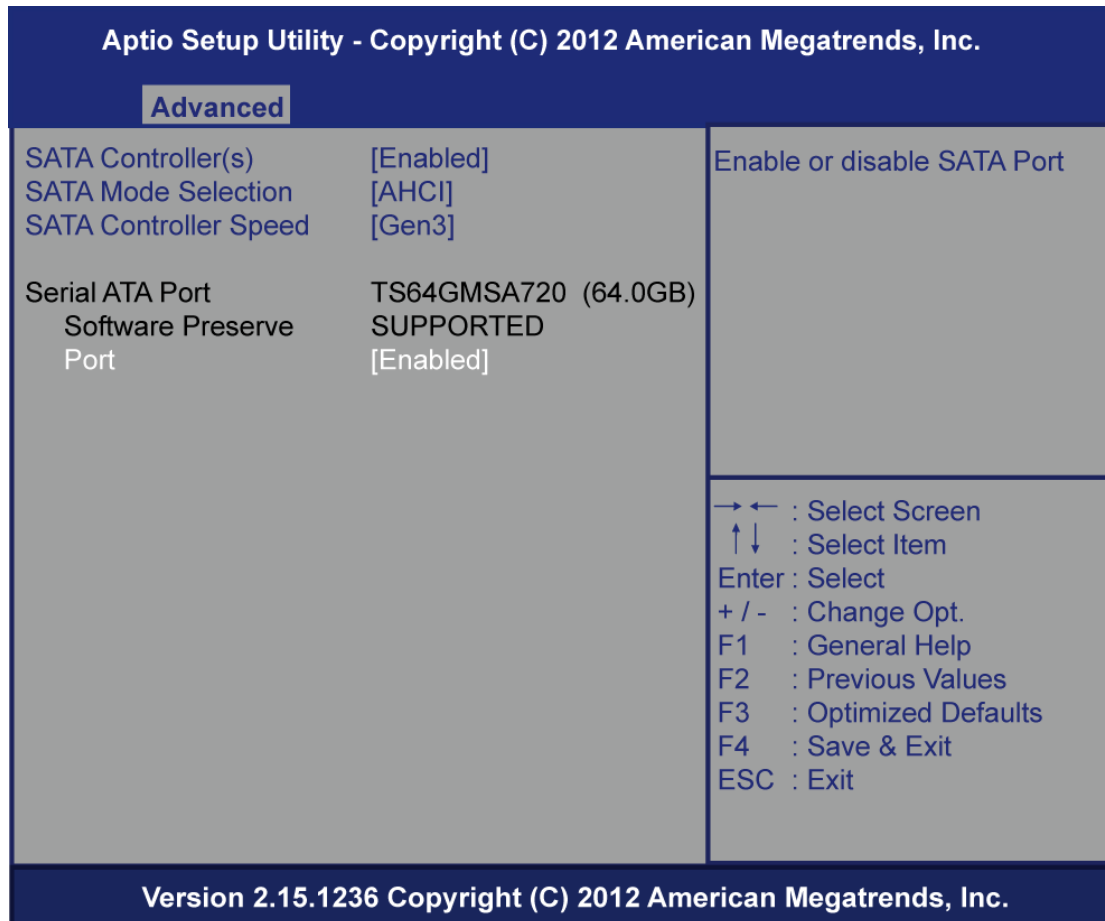

➤ **Serial-ATA Controller(S)**

Use this item to enable or disable the integrated SATA controllers. (Default: Enabled)

➤ **SATA Mode Selection**

Use this item to choose the SATA operation mode. Here are the options for your selection, IDE Mode, AHCI Mode.

➤ **SATA Controller Speed**

Use this item to change the SATA transfer rate

➤ **Serial-ATA Port**

Enable or Disable SATA Port

- **PCH-FW Configuration**

You can use this screen to confirm ME Firmware version.

The screenshot shows the Aptio Setup Utility interface. At the top, it reads "Aptio Setup Utility - Copyright (C) 2012 American Megatrends, Inc." Below this is a tab labeled "Advanced". The main area is divided into two sections. The left section displays the following information:

ME FW Version	9.0.1.1333
ME Firmware Mode	Normal Mode
ME Firmware Type	Full Sku Firmware
ME Firmware SKU	1.5MB

The right section contains a list of navigation and function keys:

- ← : Select Screen
- ↑ ↓ : Select Item
- Enter : Select
- + / - : Change Opt.
- F1 : General Help
- F2 : Previous Values
- F3 : Optimized Defaults
- F4 : Save & Exit
- ESC : Exit

At the bottom of the screen, it reads "Version 2.15.1236 Copyright (C) 2012 American Megatrends, Inc."

- **USB Configuration**

You can use this screen to select options for the USB Configuration, and change the value of the selected option. A description of the selected item appears on the right side of the screen.



- **Legacy USB Support**

This is for supporting USB device under legacy OS such DOS, when choosing AUTO”, the system will automatically detect any USB device is plugged into the computer and enable USB legacy mode when a USB device plugged and disable USB legacy mode when no USB device is plugged.

- **XHCI Mode**

Mode of operation of XHCI controller

- **USB Ports Per-Port Disable**
Control each of the USB ports (0~13) ports
- **F81801 Super IO Configuration**
Set Parameters of Serial Port (COM 1 UART)

Aptio Setup Utility - Copyright (C) 2012 American Megatrends, Inc.

Advanced	
F81801 Super IO Configuration F81801 Super IO Chip F81801 ▶ Serial Port 0 Configuration ▶ Serial Port 1 Configuration	Set Parameters of Serial Port 0 (COMA) → ← : Select Screen ↑ ↓ : Select Item Enter : Select + / - : Change Opt. F1 : General Help F2 : Previous Values F3 : Optimized Defaults F4 : Save & Exit ESC : Exit
Version 2.15.1236 Copyright (C) 2012 American Megatrends, Inc.	

- **F81801 H/W Monitor**

This screen shows the Hardware Health Configuration, And Enable or disables smart fan.

The screenshot displays the 'Aptio Setup Utility - Copyright (C) 2012 American Megatrends, Inc.' interface. A blue header bar contains the title. Below it, a grey box labeled 'Advanced' contains two main sections. The left section, 'PC Health Status', lists various system metrics: Smart Fan Function (Enabled), Smart Fan Mode Configuration (highlighted with a blue arrow), CPU temperature (+57 C), System temperature (+40 C), CPU Fan Speed (2923 RPM), +3.3V (+3.328 V), and Vcore (+1.656 V). The right section, 'Enable or Disable Smart Fan', is currently empty. A legend at the bottom right of the grey box lists navigation keys: left and right arrows for 'Select Screen', up and down arrows for 'Select Item', Enter for 'Select', + / - for 'Change Opt.', F1 for 'General Help', F2 for 'Previous Values', F3 for 'Optimized Defaults', F4 for 'Save & Exit', and ESC for 'Exit'. A dark blue footer bar at the bottom contains the text 'Version 2.15.1236 Copyright (C) 2012 American Megatrends, Inc.'

5.5 Chipset Menu

The Chipset menu allows users to change the advanced chipset settings. You can select any of the items in the left frame of the screen to go to the sub menus:

- **PCH-IO Configuration**
- **System Agent(SA) Configuration**

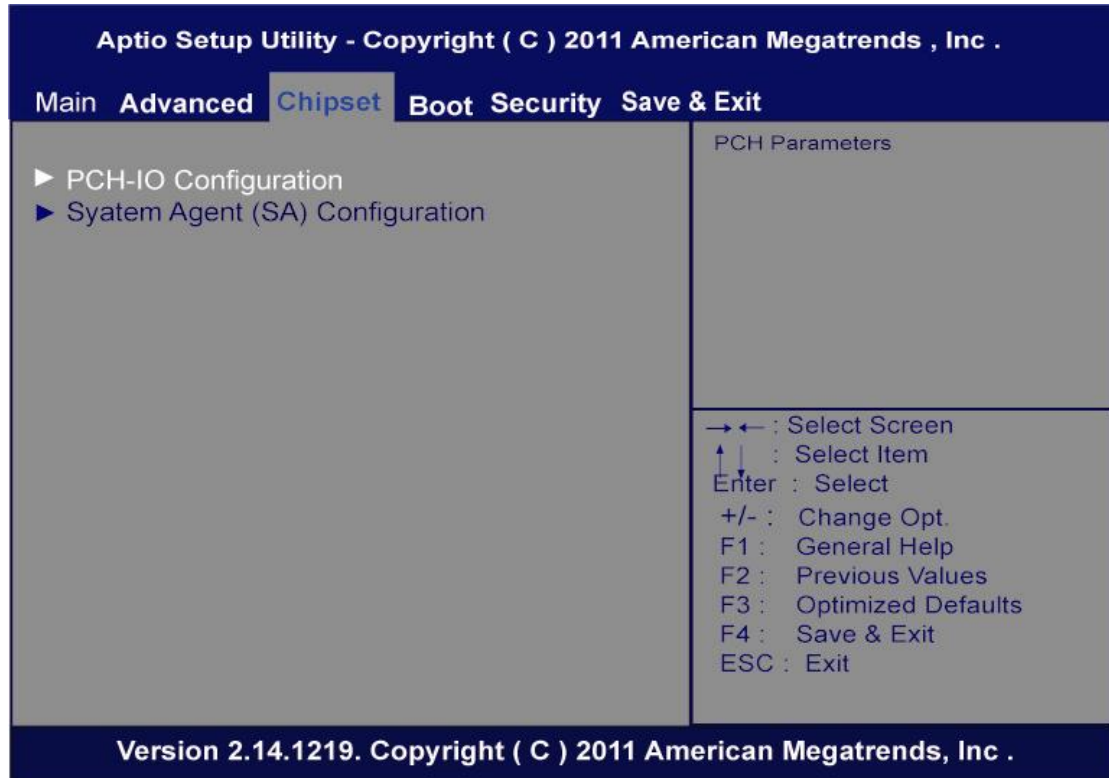

- **PCH-IO Configuration**

PCH Azalia Configuration settings

Aptio Setup Utility - Copyright (C) 2012 American Megatrends, Inc.		
Chipset		
Intel PCH RC Version	1.4.0.0	PCH Azalia Configuration Settings.
Intel PCH SKU Name	QM87	
Intel PCH Rev ID	O4/C1	
▶ PCH Azalia Configuration		
PCH LAN Controller	[Enabled]	
Wake on LAN	[Enabled]	
		→ ← : Select Screen ↑ ↓ : Select Item Enter : Select + / - : Change Opt. F1 : General Help F2 : Previous Values F3 : Optimized Defaults F4 : Save & Exit ESC : Exit
Version 2.15.1236 Copyright (C) 2012 American Megatrends, Inc.		

- **PCH Azalia Configuration**

PCH Azalia Configuration settings.

- **PCH LAN Controller**

Enable or disable onboard NIC

- **Wake on LAN**

Use this item to enable or disable integrated LAN to wak the system. (The Wake On LAN cannot be disable if ME is on at Sx satate).

- **System Agent(SA) Configuration**

Aptio Setup Utility - Copyright (C) 2012 American Megatrends, Inc.		
Chipset		
System Agent Bridge Name	Haswell	Enable or disable CPU SA Audio Device.
System Agent RC Version	1.4.0.0	
VT-d Capability	Supported	
CPU SA Audio Device (B0:D3:F0) [Enabled]		→ ← : Select Screen ↑ ↓ : Select Item Enter : Select + / - : Change Opt. F1 : General Help F2 : Previous Values F3 : Optimized Defaults F4 : Save & Exit ESC : Exit
▶ Graphics Configuration		
▶ Memory Configuration		
Version 2.15.1236 Copyright (C) 2012 American Megatrends, Inc.		

- **CPU SA Audio Device (BO:D3:F0)**
Enable or disable CPU SA audio device
- **Graphics Configuration**
Config graphics settings.
- **Memory Information**
Memory configuration parameters

Aptio Setup Utility - Copyright (C) 2012 American Megatrends, Inc.		
Chipset		
Graphics Configuration		Select the Video Device which will be activated during POST. This has no effect if external graphics present. Secondary boot display selection will appear based on your selection. VGA modes will be Supported only on primary display
IGFX VBIOS Version	2164	
IGfX Frequency	800 MHz	
Primary Display	[IGFX]	→ ← : Select Screen ↑ ↓ : Select Item Enter : Select + / - : Change Opt. F1 : General Help F2 : Previous Values F3 : Optimized Defaults F4 : Save & Exit ESC : Exit
Primary IGFX Boot Display	[Auto]	
DVMT Pre-Allocated	[32M]	
Version 2.15.1236 Copyright (C) 2012 American Megatrends, Inc.		

➤ **Primary IGFX Boot Display**

Select the video device which will be activated during POST. This has no effect if external graphics presents. Secondary boot display selection will appear base on your selection. VGA modes will be supported only on primary display

➤ **DVMT Pre-Allocated**

Pre-allocated memory is the small amount of system memory made available at boot time by the system BIOS for video. Pre-allocated memory is also known as locked memory. This is because it is "locked" for video use only and as such, is invisible and unable to be used by the operating system.

- **Memory Information**

Memory configuration parameters

Aptio Setup Utility - Copyright (C) 2012 American Megatrends, Inc.		
Chipset		
Memory Information		Maximum Value of TOLUD. Dynamic assignment would adjust TOLUD automatically based on largest MMIO length of installed graphic controller
Memory RC Version	1.4.0.3	
Memory Frequency	1600 Mhz	
Total Memory	8192 MB (DDR3)	
Memory Voltage	1.35v	
DIMM	8192 MB (DDR3)	
Max TOLUD	[Dynamic]	
		→ ← : Select Screen ↑ ↓ : Select Item Enter : Select + / - : Change Opt. F1 : General Help F2 : Previous Values F3 : Optimized Defaults F4 : Save & Exit ESC : Exit
Version 2.15.1236 Copyright (C) 2012 American Megatrends, Inc.		

- **Max TOLUD**

This item allows you to set Maximum Value of TOLUD

5.6 Boot Menu

The Boot menu allows users to change boot options of the system. You can select any of the items in the left frame of the screen to go to the sub menus:

(images requires to update)

- **Setup Prompt Timeout**
- **Boot up Num Lock State**
- **Quiet Boot**
- **Launch PXE OpROM policy**
- **Boot Option #1**
- **Boot Option #2**
- **Hard Drive BBS Priorities**

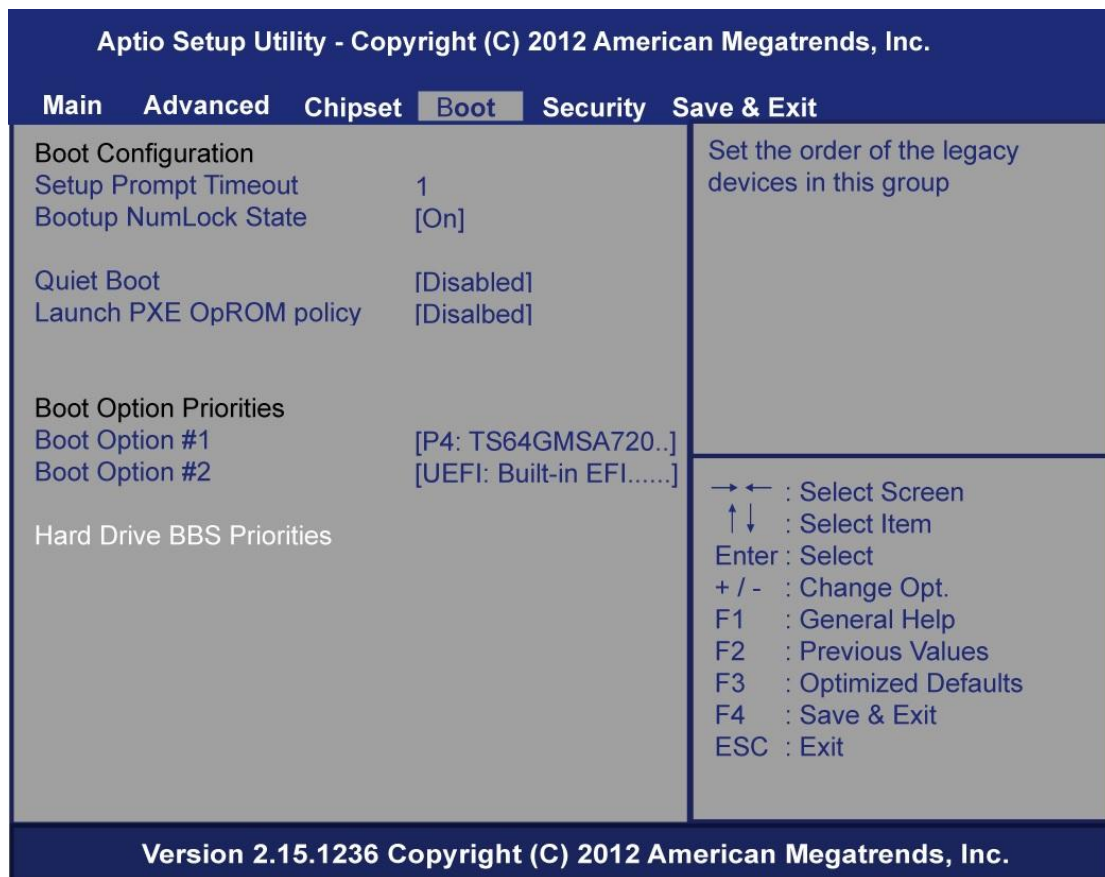

- **Setup Prompt Timeout**
Set the Timeout for wait press key to enter Setup Menu
- **Boot up Mum Lock State**
Use this item to select the power-on state for the Mum Lock. The default setting is on.
- **Quiet Boot**
Use this item to enable or disable the Quite Boot state. The default setting is disabling.

- **Launch PXE OpROM policy**
Controls the execution of UEFI and Legacy PXE OpROM
- **Boot Option #1**
Sets the system boot order
- **Boot Option #2**
Sets the system boot order
- **Hard Drive BBS Priorities**
Set the order of the legacy devices in this group.

5.7 Security Menu

The Security menu allows users to change the security settings for the system.

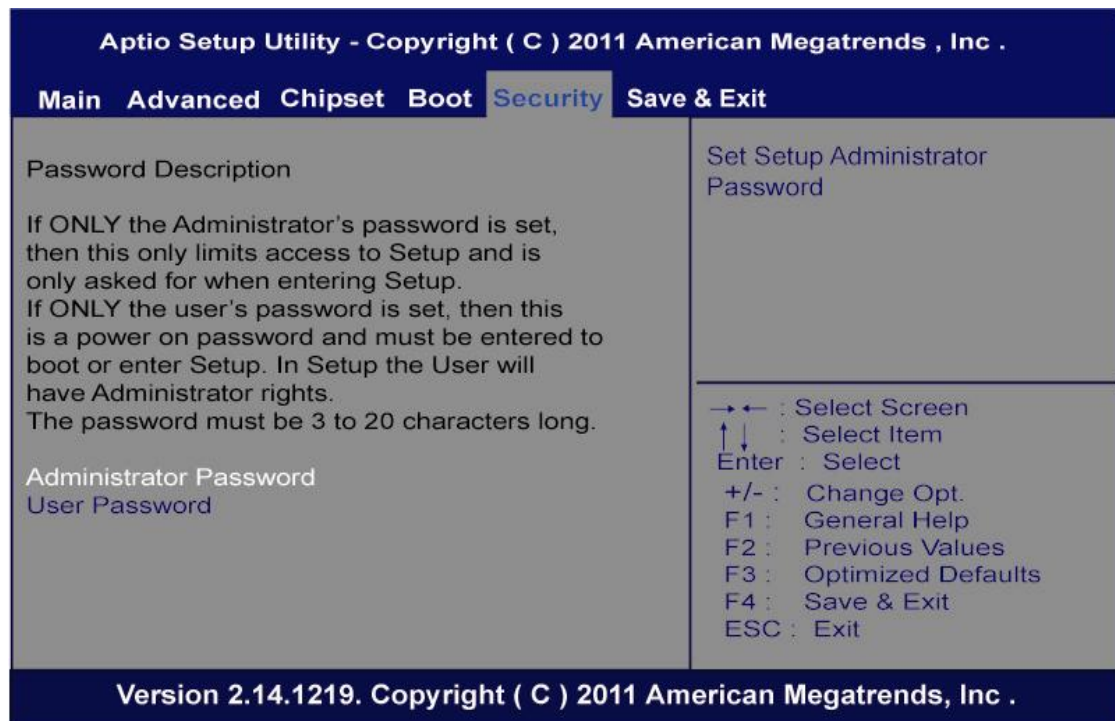

- **Administrator Password**
This item indicates whether an administrator password has been set. If the password has been installed, Installed displays. If not, Not Installed displays.
- **User Password**
This item indicates whether a user password has been set. If the password has been installed, Installed displays. If not, Not Installed displays.

5.8 Save & Exit Menu

The Save & Exit menu allows users to load your system configuration with optimal or failsafe default values.

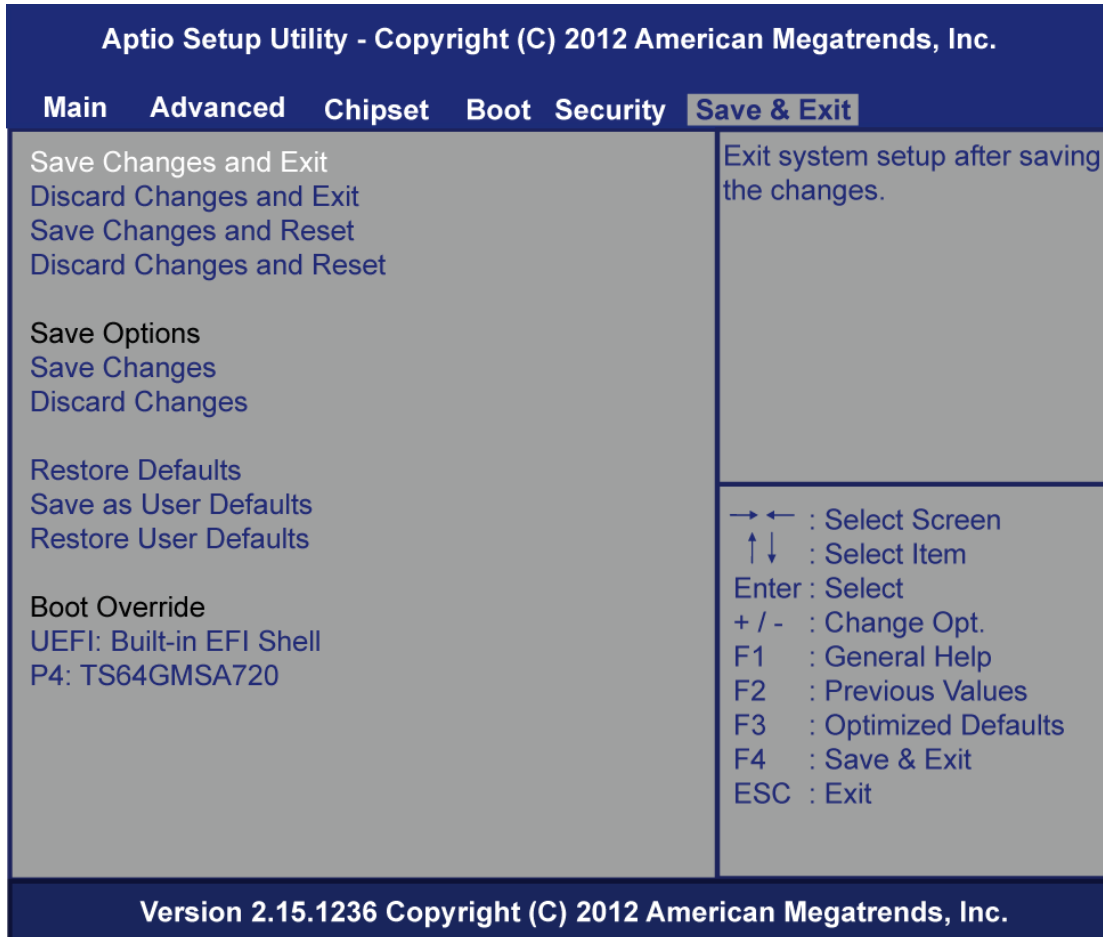

➤ **Save Changes and Exit**

When you have completed the system configuration changes, select this option to leave Setup and return to Main Menu. Select Save Changes and Exit from the Save & Exit menu and press <Enter>. Select yes to save changes and exit.

➤ **Discard Changes and Exit**

Select this option to quit Setup without making any permanent changes to the system configuration and return to Main Menu. Select Discard Changes and Exit from the Save & Exit menu and press <Enter>. Select Yes to discard changes and exit.

➤ **Save Changes and Reset**

When you have completed the system configuration changes, select this option to leave Setup and reboot the computer so the new system configuration parameters can take effect. Select Save Changes and Reset from the Save & Exit menu and press <Enter>. Select Yes to save changes and reset.

➤ **Discard Changes and Reset**

Select this option to quit Setup without making any permanent changes to the system configuration and reboot the computer. Select Discard Changes and Reset from the Save & Exit menu and press <Enter>. Select Yes to discard changes and reset.

➤ **Save Changes and Reset**

When you have completed the system configuration changes, select this option to save changes. Select Save Changes from the Save & Exit menu and press <Enter>. Select Yes to save changes.

➤ **Discard Changes and Reset**

Select this option to quit Setup without making any permanent changes to the system configuration. Select Discard Changes from the Save & Exit menu and press <Enter>. Select Yes to discard changes.

➤ **Save Changes**

When you have completed the system configuration changes, select this option to save changes. Select Save Changes from the Save & Exit menu and press <Enter>. Select Yes to save changes.

➤ **Discard Changes**

Select this option to quit Setup without making any permanent changes to the system configuration. Select Discard Changes from the Save & Exit menu and press <Enter>. Select Yes to discard changes.

➤ **Restore Defaults**

It automatically sets all Setup options to a complete set of default settings when you select this option. The Optimal settings are designed for maximum system performance, but may not work best for all computer applications. In particular, do not use the Optimal Setup options if your computer is experiencing system configuration problems. Select Restore Defaults from the save & Exit menu and press <Enter>.

➤ **Save as User Defaults**

Select this option to save system configuration changes done so far as User Defaults. Select Save as User Defaults from the Save & Exit menu and press <Enter>.

➤ **Restore User Defaults**

It automatically sets all Setup options to a complete set of User Defaults when you select this option. Select Restore User Defaults from the Save & Exit menu and press <Enter>.

This page is intentionally left blank.

APPENDIX A REFERENCE DOCUMENTS

Document	Document No./Location
Digital Signage Open Pluggable Specification	324427
JAE TX24/TX25 connector product brief	http://iae-connectors.com/en/pdf/2008-40-TX24TX25.pdf
JAE plug connector details and drawing	http://iae-connectors.com/en/product_en.cfm?l_code=EN&series_code=TX24/TX25&product_number=TX25-80P-LT-H1E
JAE receptacle connector details and drawing	http://iae-connectors.com/en/product_en.cfm?l_code=EN&series_code=TX24/TX25&product_number=TX24-80R-LT-H1E

This page is intentionally left blank.

APPENDIX B

WATCHDOG TIMER

Watchdog Timer Setting

After the system stops working for a while, it can be auto-reset by the Watchdog Timer. The integrated Watchdog Timer can be set up in the system reset mode by program.

Using the Watchdog Function Start

1. Enable configuration (Following is example to enable configuration by using debug)

-O 2E 87

-O 2E 87

2. Select Logic device:

-O 2E 07

-O 2F 07

3. WDT Device Enable

-O 2E 30

-O 2F 01

4. Activate WDT:

-O 2E F0

-O 2F 80

5. Set base timer:

-O 2E F6

-O 2F 0A → Set Reset Time (Ex. A: 10 Sec)

6. Set timer unit

-O 2E F5

-O 2F 71 (1: Sec ; 9: Minute)

This page is intentionally left blank.

APPENDIX C

INTEL® RAPID STORAGE TECHNOLOGY



NOTE: *This feature requires that the SATA controller be set to RAID mode via the system BIOS.*

Intel® Smart Response Technology is an Intel® Rapid Storage Technology (RST) caching feature that improves computer system performance. It allows a user to configure computer systems with an SSD used as cache memory between the hard disk drive and system memory. This provides the advantage of having a hard disk drive (or a RAID volume) for maximum storage capacity while delivering an SSD-like overall system performance experience. Intel® Smart Response Technology caching is implemented as a single drive letter solution; no additional drive letter is required for the SSD device used as cache.

System Requirements:

For a system to support Intel Smart Response Technology it must have the following:

1. Intel® HM86 Express Chipset-based desktop board
2. System BIOS with SATA mode set to RAID
3. Intel Rapid Storage Technology software 10.5 version release or later
4. Single Hard Disk Drive(HDD) or multiple HDD's in a single RAID volume.
5. Solid State Drive(SSD) with a minimum capacity of 18.6GB
6. Operating system: Windows* 7, Microsoft Windows* 8.1 and Windows* 10.

System Requirements:

Configuration SATA Mode in BIOS Setup

1. Press the F2 during boot up to enter the BIOS setup menu
2. Go to Configuration > SATA Drives
3. Select the setting for Chipset SATA Mode and change the value to RAID.
4. Press the F10 key to save settings and restart the system.

System Requirements:

5. You may now begin installation of the operating system on the HDD(or RAID volume)
6. Install all required device drivers
7. Install the Intel Rapid Storage Technology software version 10.5 or later

Enable Intel Smart Response Technology



NOTE: *The Intel RST software denotes Intel Smart Response Technology as Accelerate*

8. Run the Intel RST software through the ALL Programs menu or the task bar icon.
9. Click "Enable acceleration" either under "Status" or "Accelerate"



10. Select the SSD to be used as a cache device.
11. Select the size from the SSD to be allocated for the cache memory.

 **NOTE:** Any remaining space on the SSD may be used for data storage using the simple data single-disk RAID 0 volumes that is automatically created.

12. Select the HDD (or RAID volume) to be accelerated. It is highly recommended to accelerate the system volume or system disk for maximum performance.
13. Select the acceleration mode, and then click "OK". By default, Enhanced mode is selected.

 **NOTE:** Enhanced mode (default) Acceleration optimized for data protection.

Maximized mode: Acceleration optimized for input/output performance.

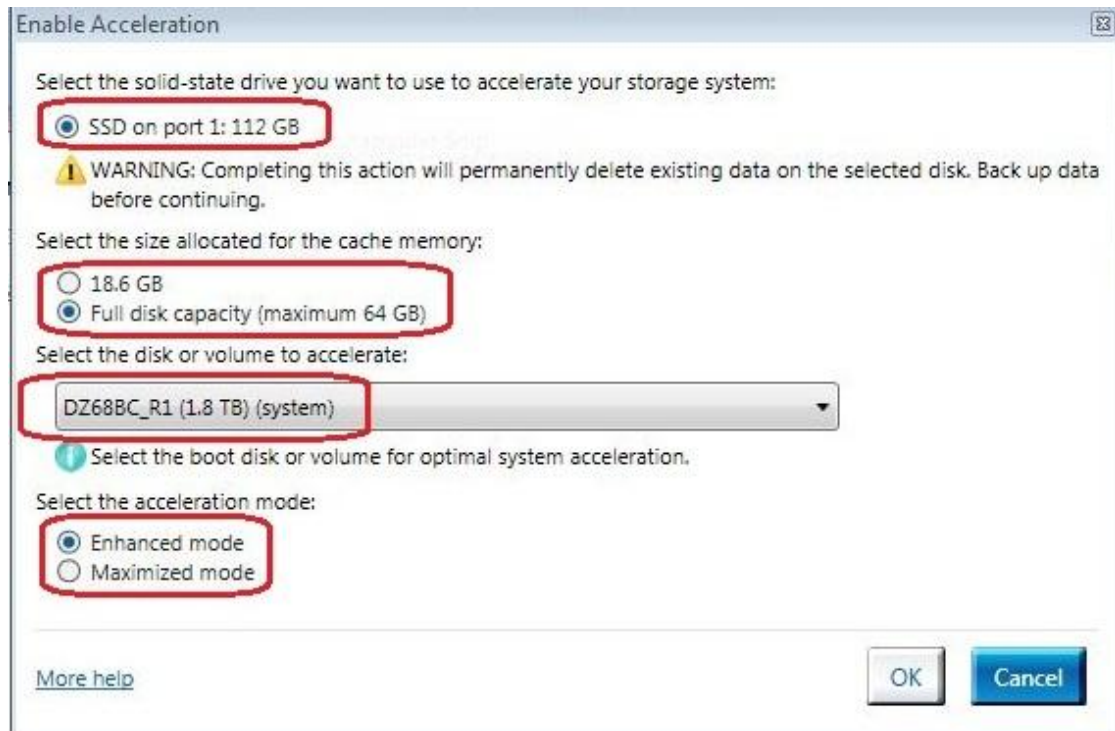

14. The page refreshes and reports the new acceleration configuration in the Acceleration View.
15. Congratulations! Your system is now successfully configured with the Intel Smart Response Technology!

For more information on Intel Smart Response Technology, please visit:

http://www.intel.com/p/en_US/support/highlights/chpsts/imsm

Remark: Intel® Rapid Start Technology requires an appropriate processor be installed in the platform. See processor collateral for further details.

This page is intentionally left blank.